

M.LOOK A2 Glass-fibre Mineral Core Panel ML-07-VRF Visible Rivet Fix

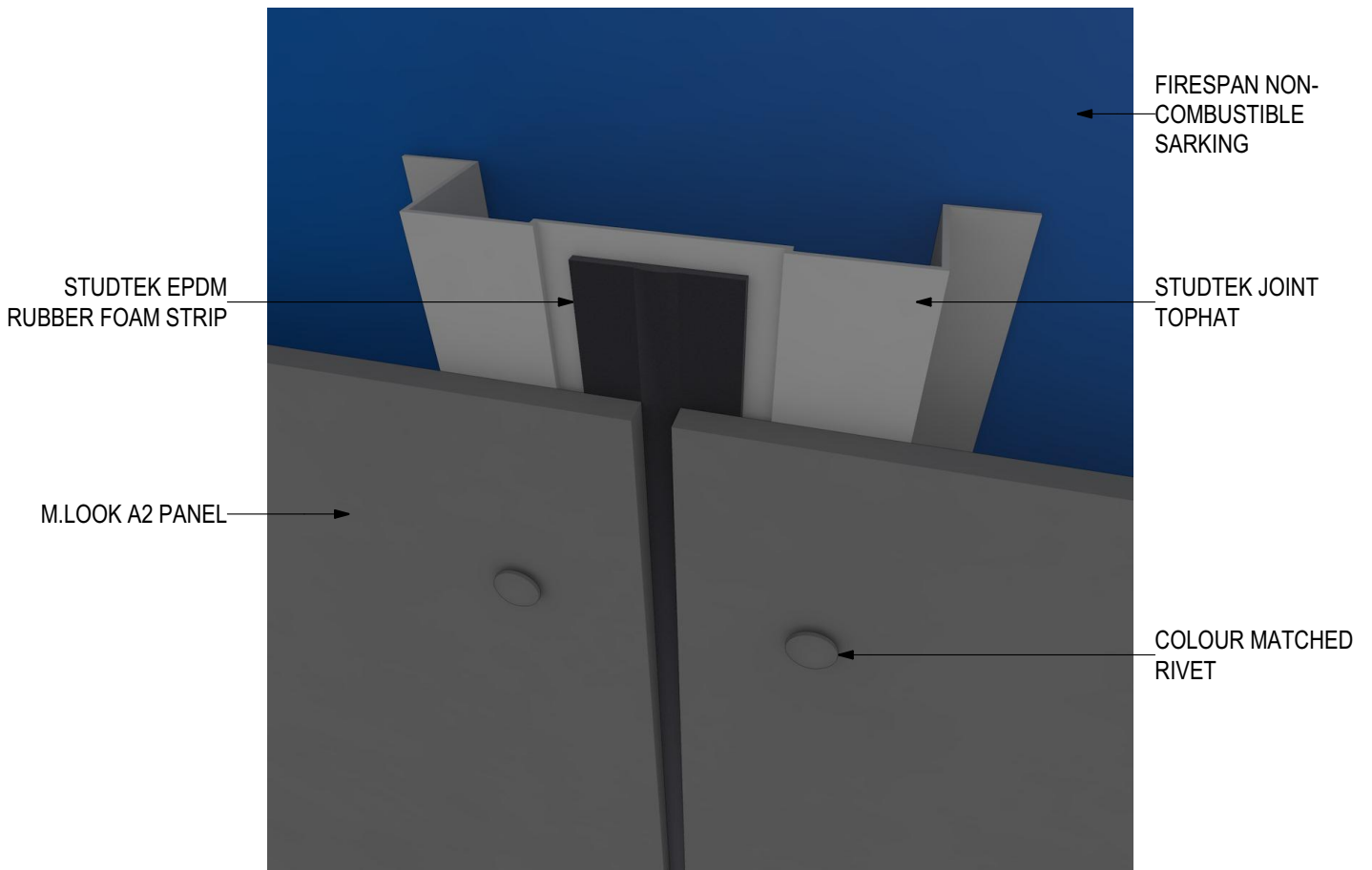

INSTALLATION DETAILS

Disclaimer: These details are general design details for use as a guide. Any use is at their own discretion and risk.

M.LOOK A2 Glass-fibre Mineral Core Panel ML-07-VRF Visible Rivet Fix

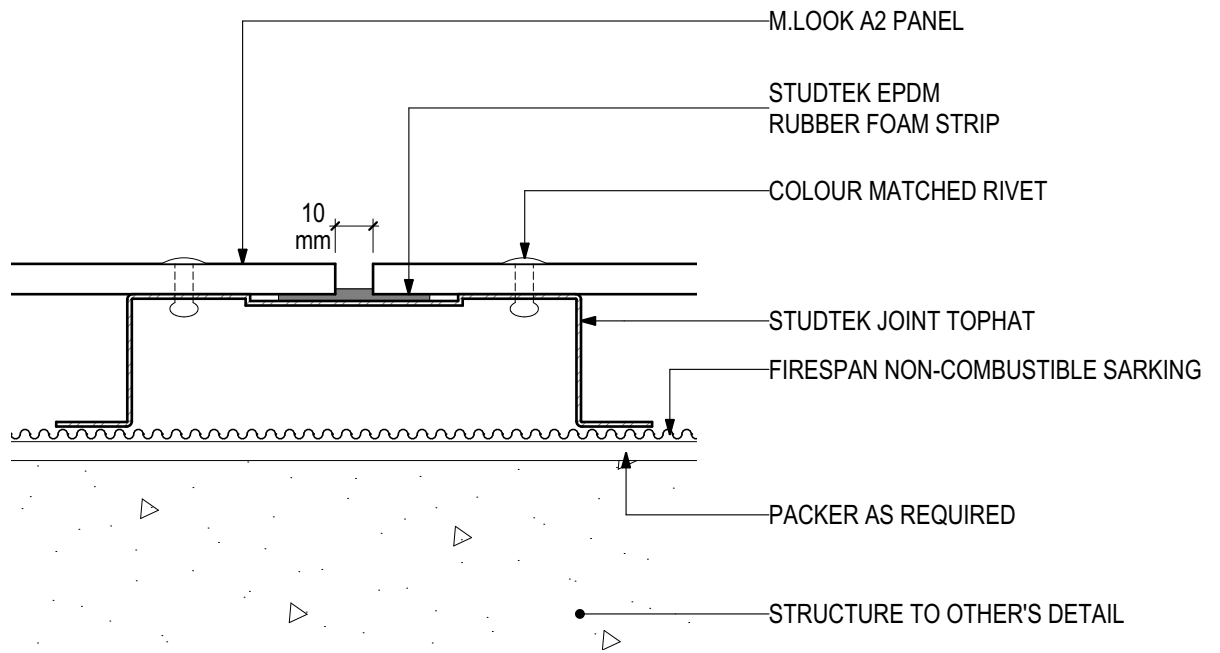

D.01 - TYPICAL FIXING DETAIL

SCALE 1:2

Disclaimer: These details are general design details for use as a guide. Any use is at their own discretion and risk.

M.LOOK A2 Glass-fibre Mineral Core Panel
ML-07-VRF Visible Rivet Fix

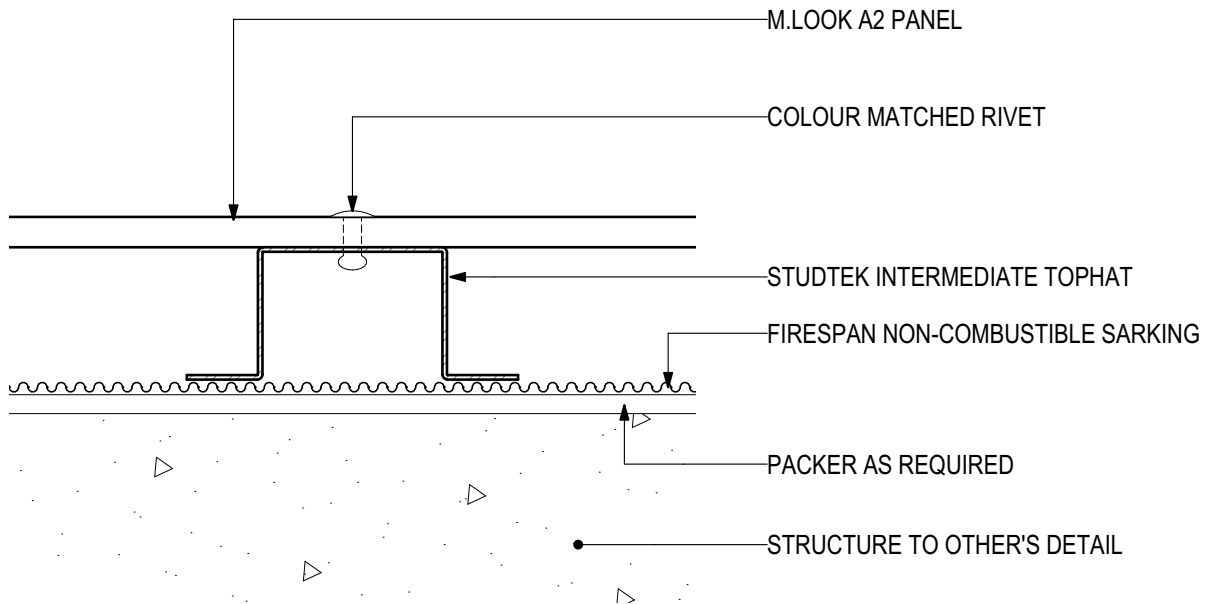

D.02 - INTERMEDIATE DETAIL

SCALE 1:2

Disclaimer: These details are general design details for use as a guide.
Any use is at their own discretion and risk.

M.LOOK A2 Glass-fibre Mineral Core Panel
ML-07-VRF Visible Rivet Fix

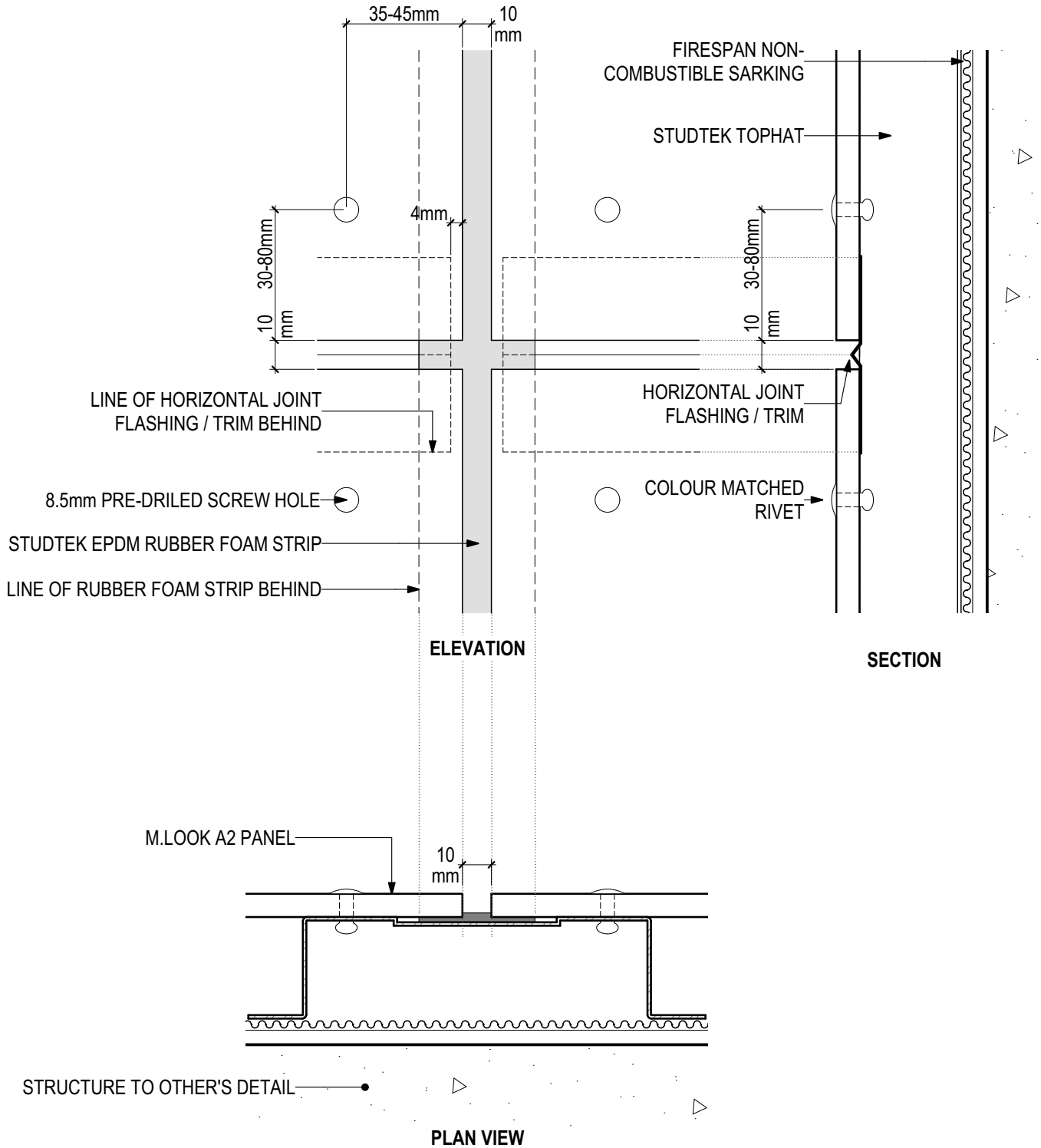

D.03 - HORIZONTAL CLOSED JOINT

SCALE 1:2

Disclaimer: These details are general design details for use as a guide. Any use is at their own discretion and risk.

M.LOOK A2 Glass-fibre Mineral Core Panel ML-07-VRF Visible Rivet Fix

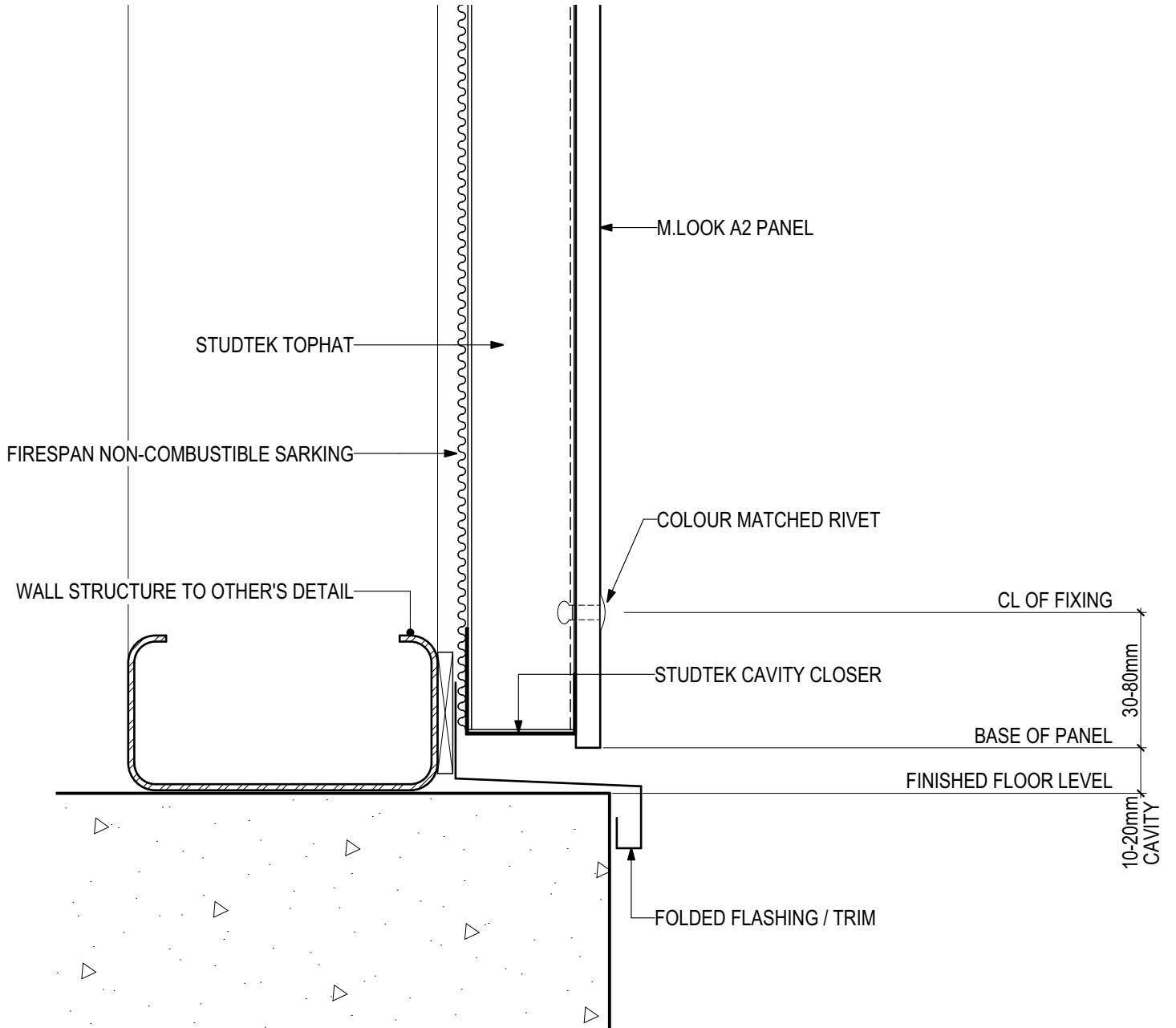

D.04 - BASE DETAIL

SCALE 1:2

Disclaimer: These details are general design details for use as a guide. Any use is at their own discretion and risk.

M.LOOK A2 Glass-fibre Mineral Core Panel ML-07-VRF Visible Rivet Fix

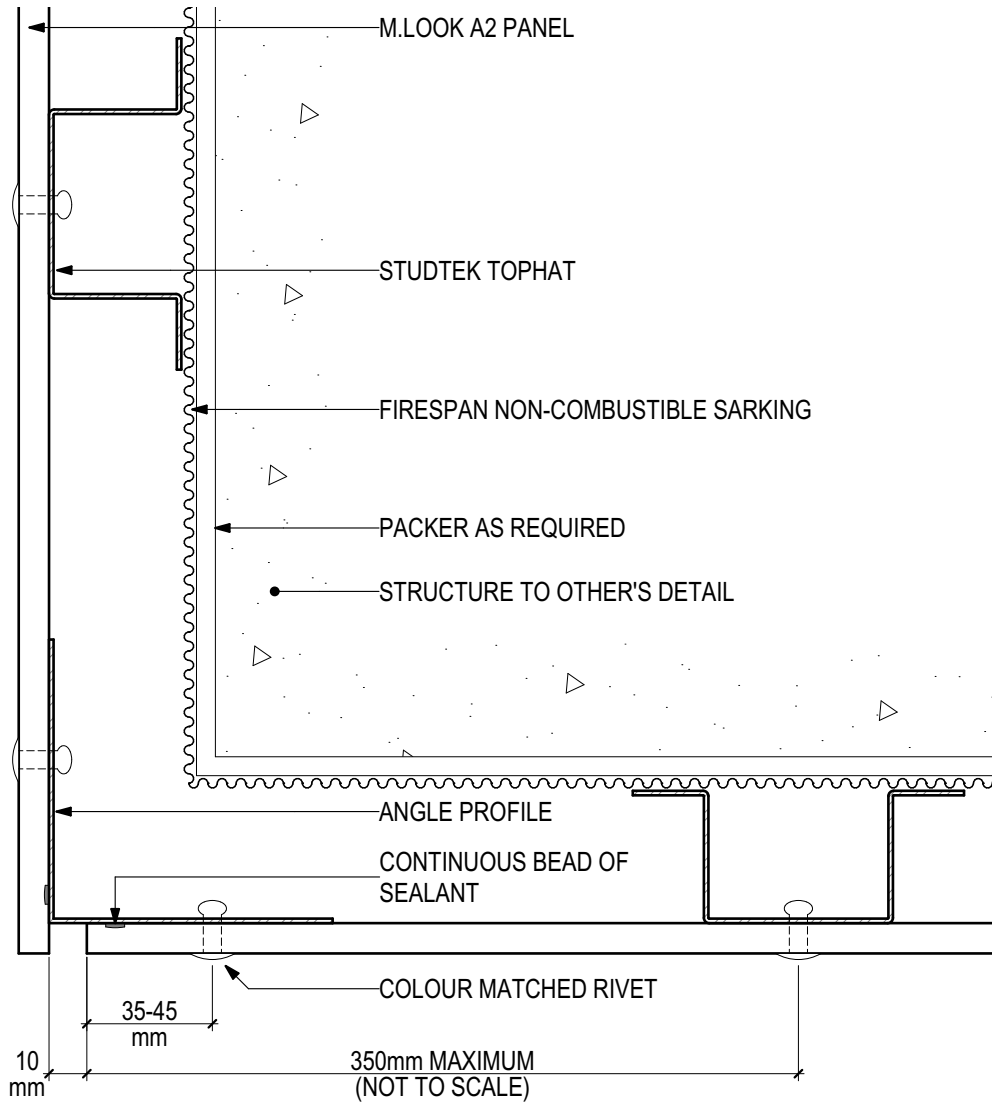

D.05 - EXTERNAL CORNER

SCALE 1:2

Disclaimer: These details are general design details for use as a guide. Any use is at their own discretion and risk.

**M.LOOK A2 Glass-fibre Mineral Core Panel
ML-07-VRF Visible Rivet Fix**

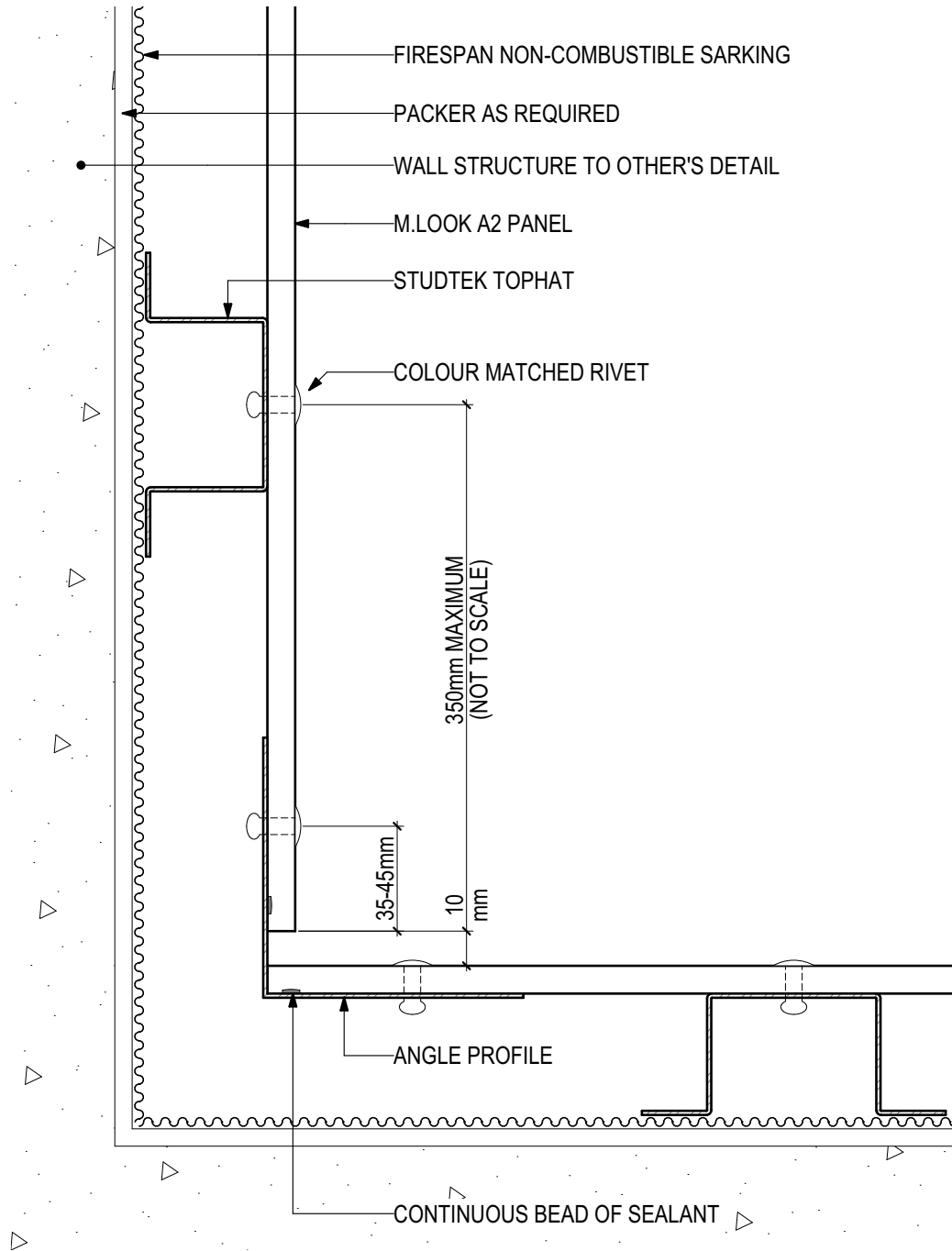

D.06 - INTERNAL CORNER

SCALE 1:2

Disclaimer: These details are general design details for use as a guide. Any use is at their own discretion and risk.

M.LOOK A2 Glass-fibre Mineral Core Panel
ML-07-VRF Visible Rivet Fix

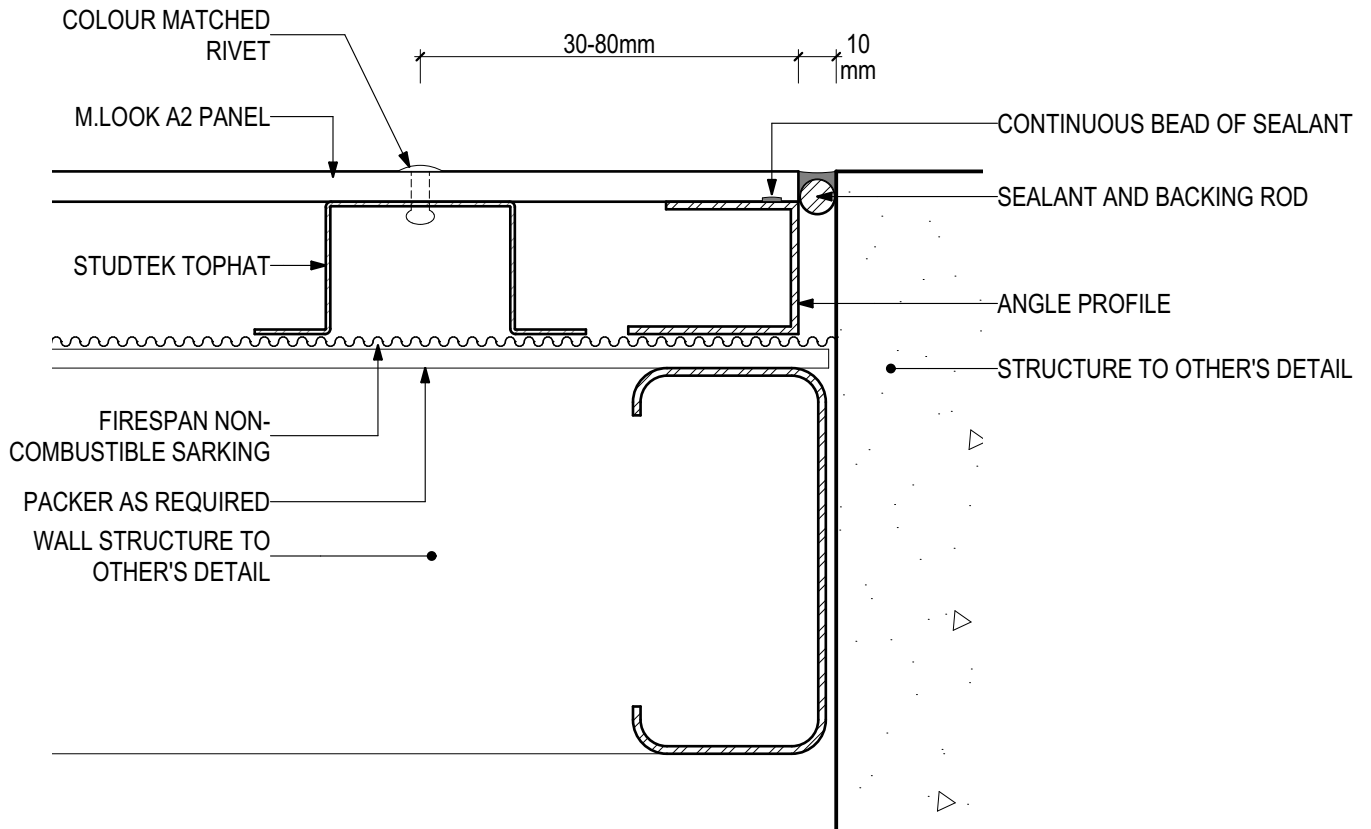

D.07 - WALL ABUTMENT

SCALE 1:2

Disclaimer: These details are general design details for use as a guide. Any use is at their own discretion and risk.

**M.LOOK A2 Glass-fibre Mineral Core Panel
ML-07-VRF Visible Rivet Fix**

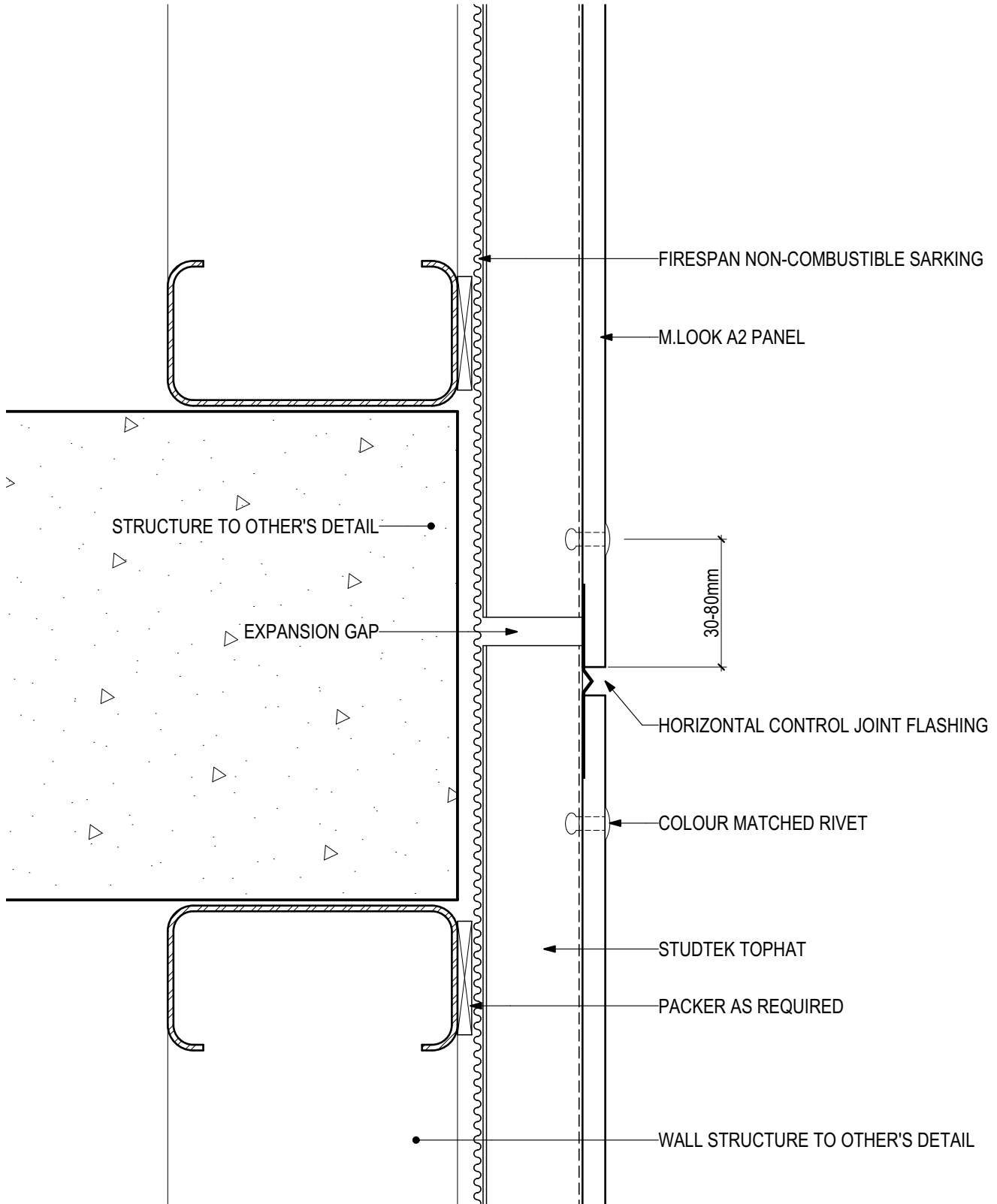

D.08 - HORIZONTAL CONTROL JOINT

SCALE 1:2

Disclaimer: These details are general design details for use as a guide. Any use is at their own discretion and risk.

**M.LOOK A2 Glass-fibre Mineral Core Panel
ML-07-VRF Visible Rivet Fix**

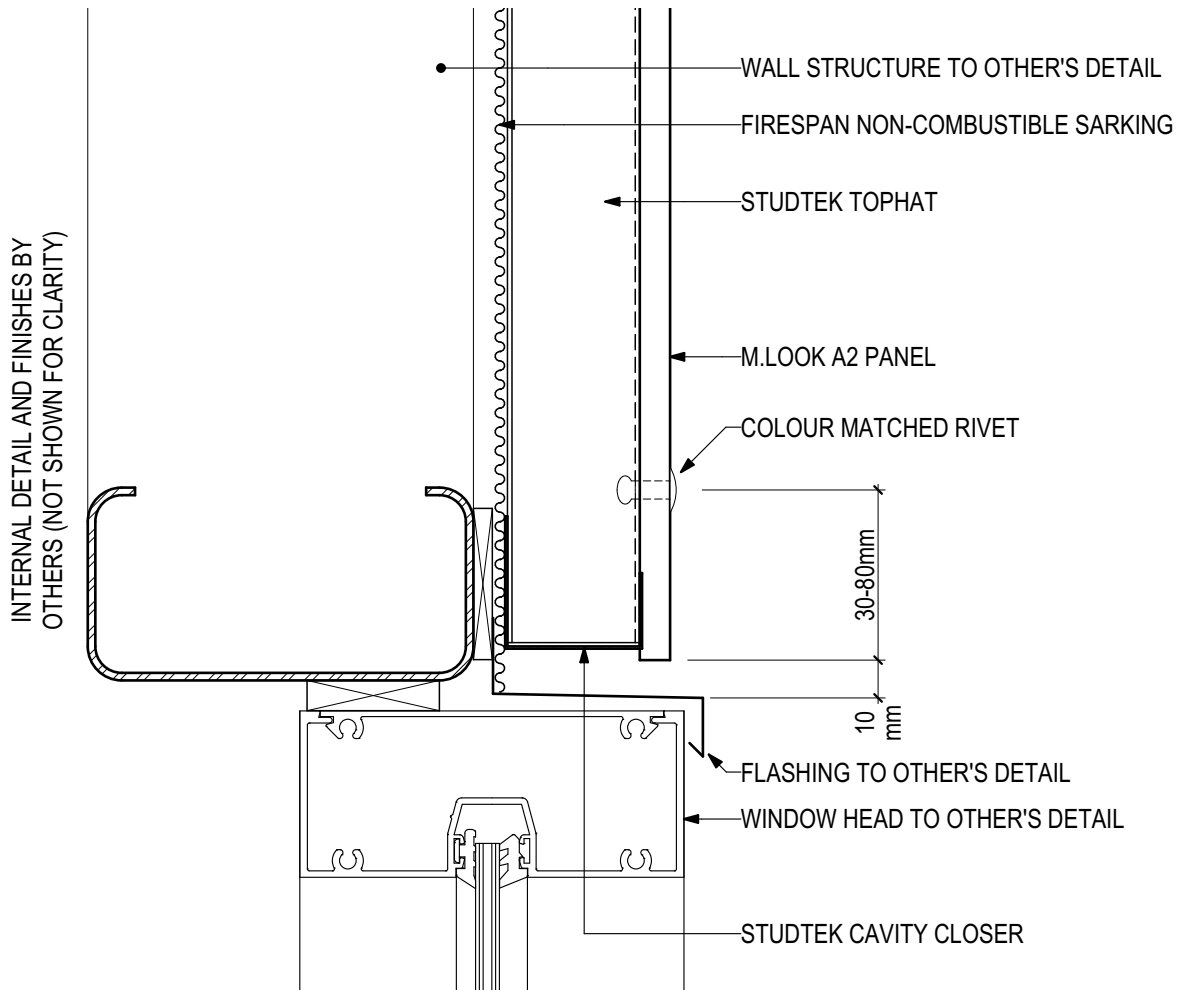

D.09 - WINDOW HEAD

SCALE 1:2

Disclaimer: These details are general design details for use as a guide. Any use is at their own discretion and risk.

M.LOOK A2 Glass-fibre Mineral Core Panel ML-07-VRF Visible Rivet Fix

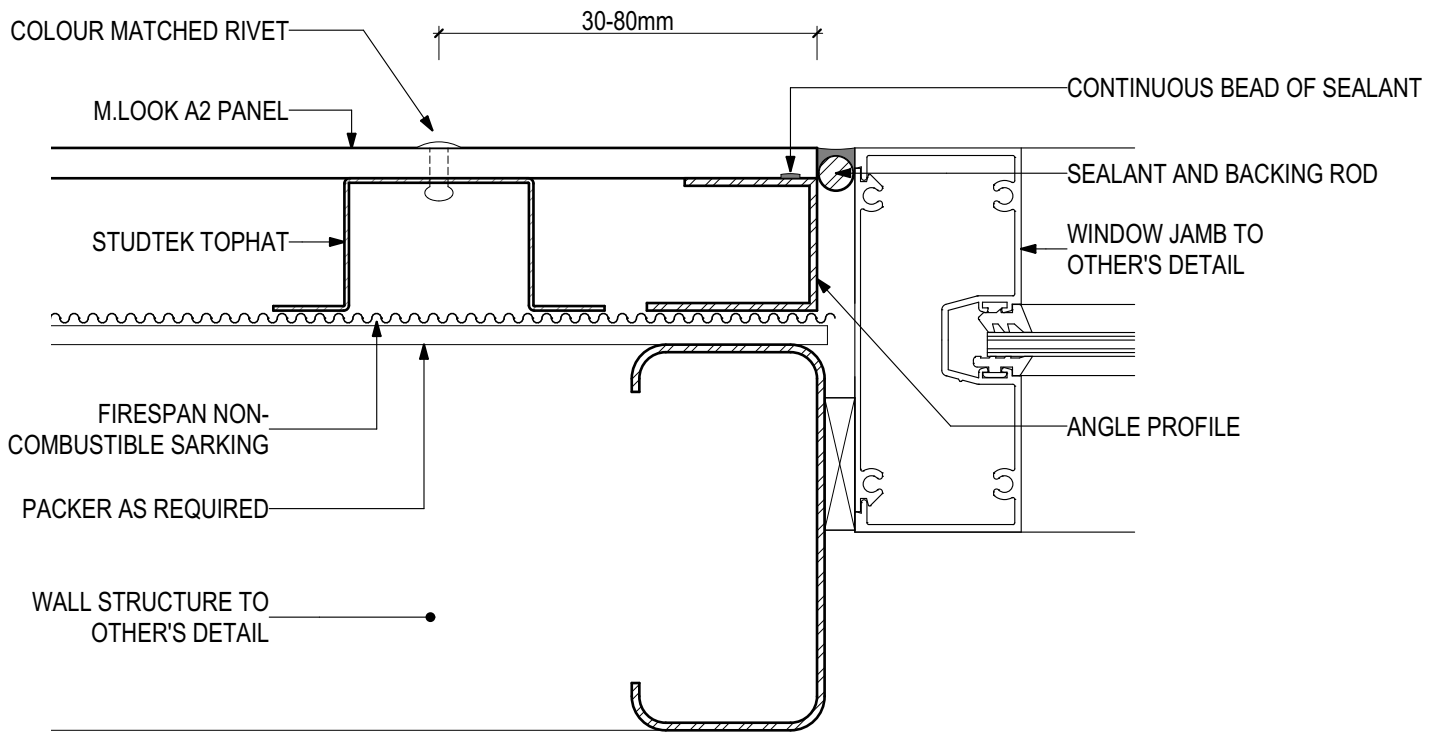

INTERNAL DETAIL AND FINISHES BY OTHERS (NOT SHOWN FOR CLARITY)

D.10 - WINDOW JAMB

SCALE 1:2

Disclaimer: These details are general design details for use as a guide. Any use is at their own discretion and risk.

M.LOOK A2 Glass-fibre Mineral Core Panel ML-07-VRF Visible Rivet Fix

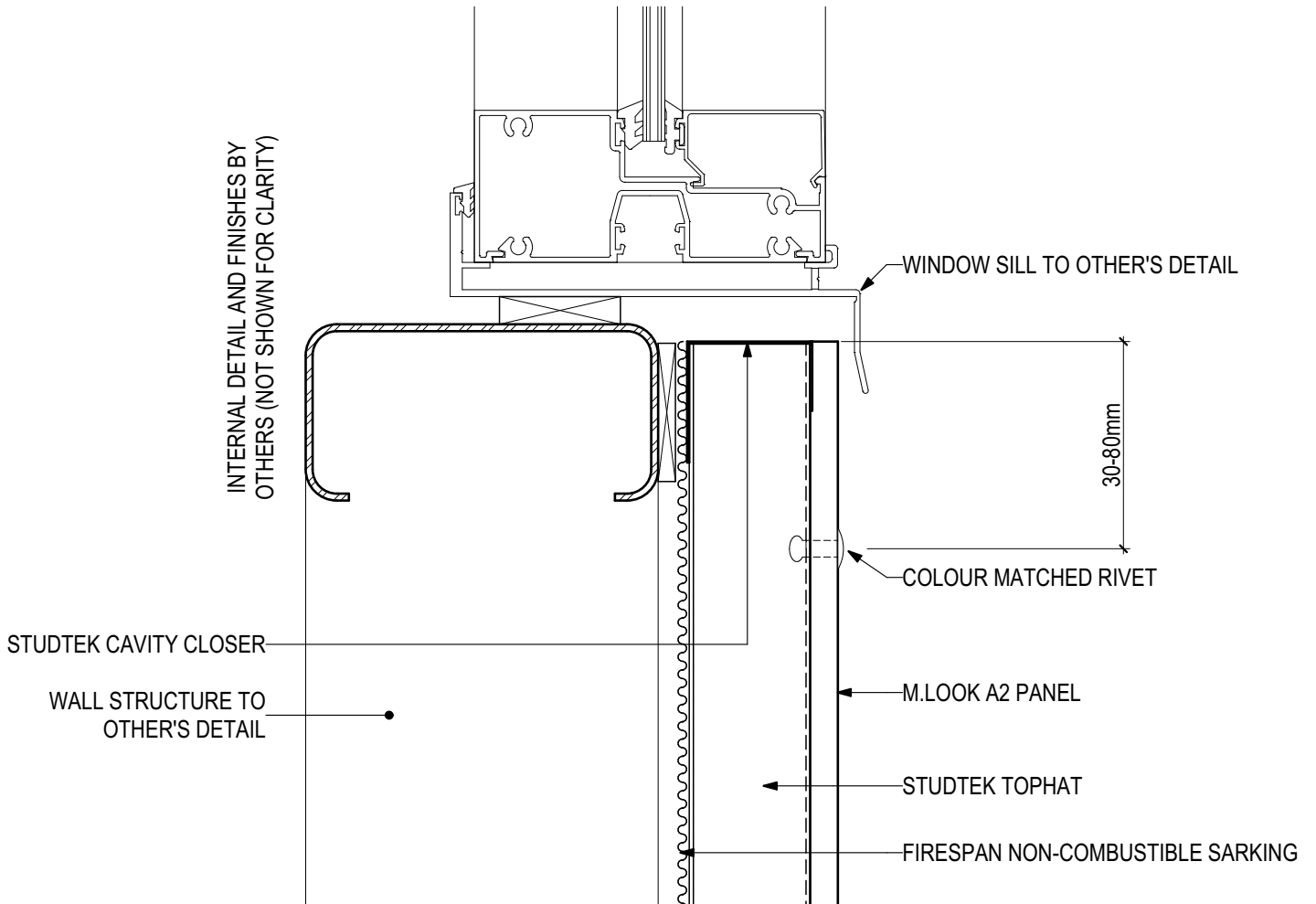

D.11 - WINDOW SILL

SCALE 1:2

Disclaimer: These details are general design details for use as a guide. Any use is at their own discretion and risk.

**M.LOOK A2 Glass-fibre Mineral Core Panel
ML-07-VRF Visible Rivet Fix**

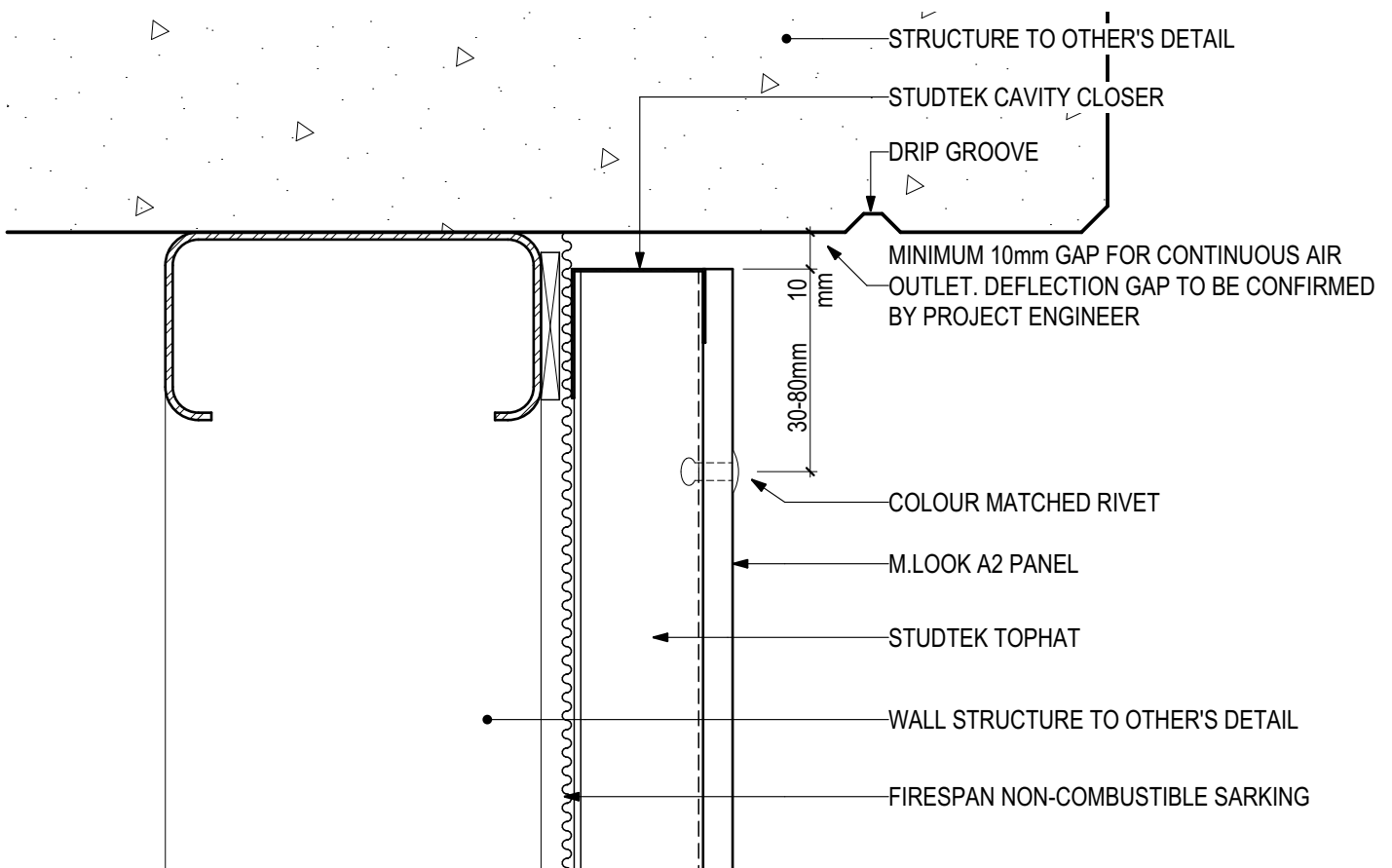

D.12 - HEAD AT SLAB JUNCTION

SCALE 1:2

Disclaimer: These details are general design details for use as a guide. Any use is at their own discretion and risk.

M.LOOK A2 Glass-fibre Mineral Core Panel ML-07-VRF Visible Rivet Fix

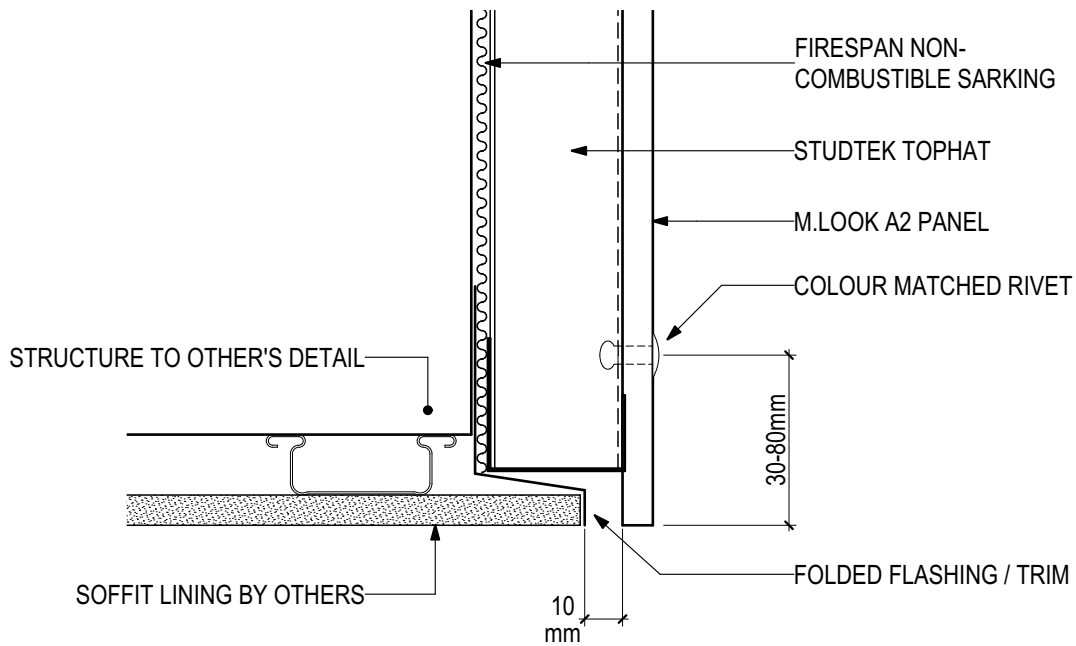

D.13 - SOFFIT JUNCTION

SCALE 1:2

Disclaimer: These details are general design details for use as a guide. Any use is at their own discretion and risk.

M.LOOK A2 Glass-fibre Mineral Core Panel ML-07-VRF Visible Rivet Fix

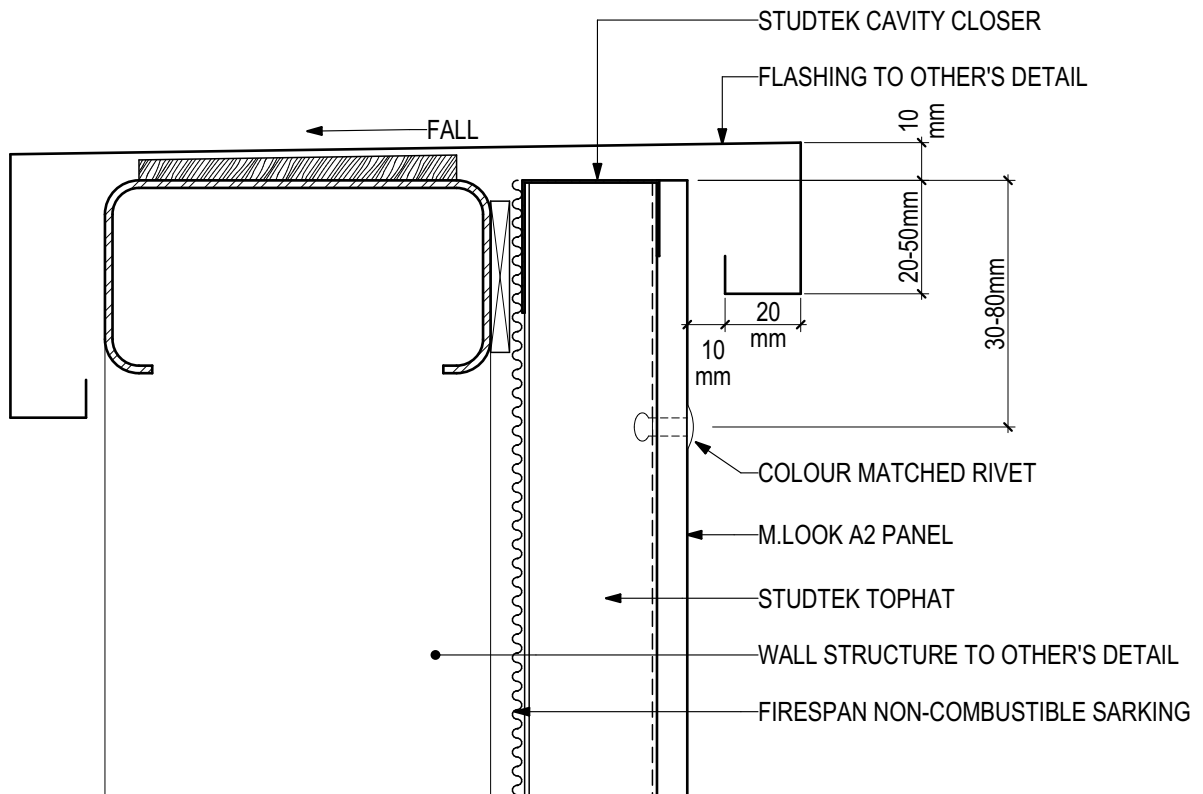

D.14 - PARAPET DETAIL

SCALE 1:2

Disclaimer: These details are general design details for use as a guide. Any use is at their own discretion and risk.