

ULTRALIGN Groove Aluminium Cladding System UL-GR-CSF Concealed Screw Fix

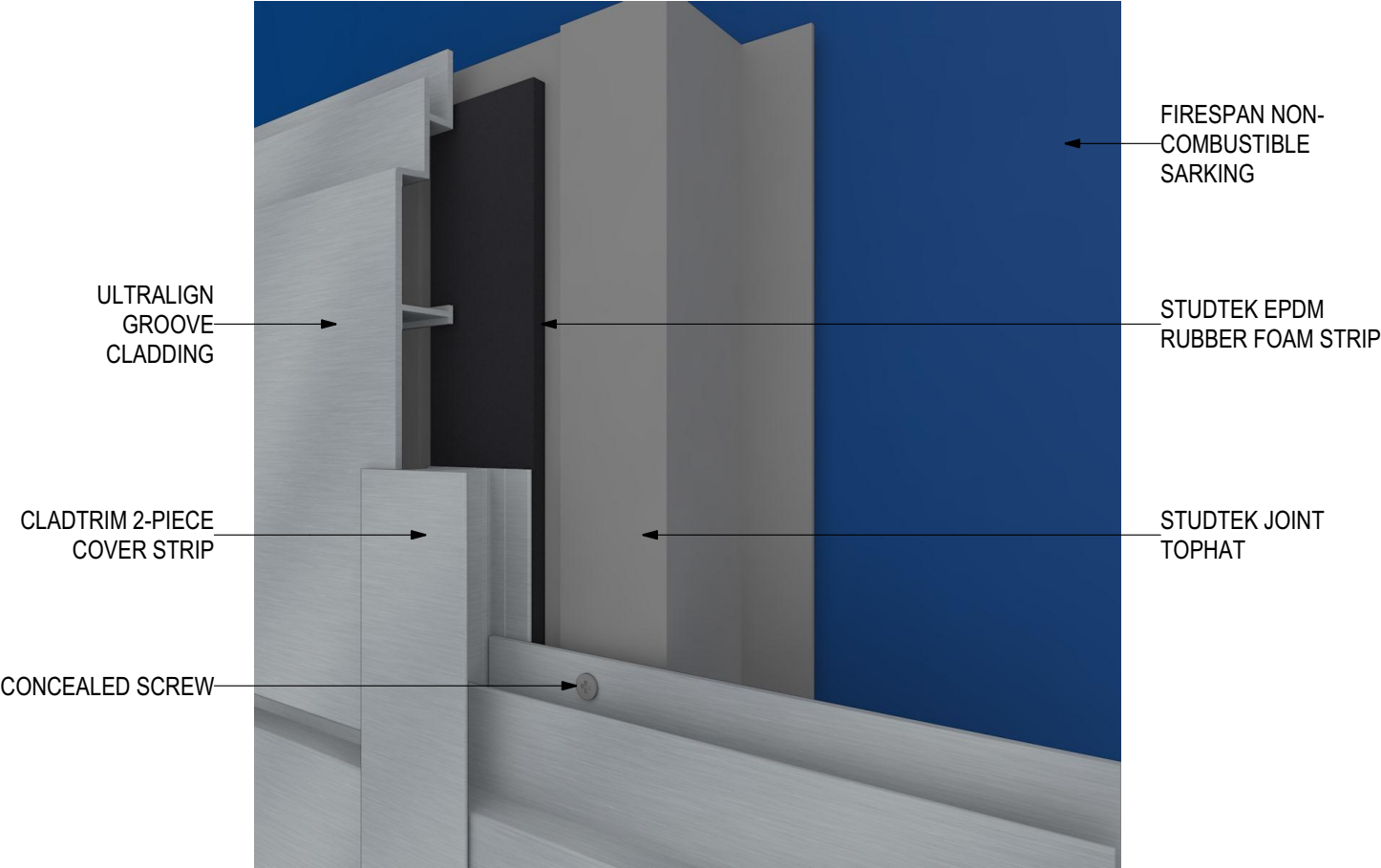

INSTALLATION DETAILS

Disclaimer: These details are general design details for use as a guide. Any use is at their own discretion and risk.

ULTRALIGN Groove Aluminium Cladding System UL-GR-CSF Concealed Screw Fix

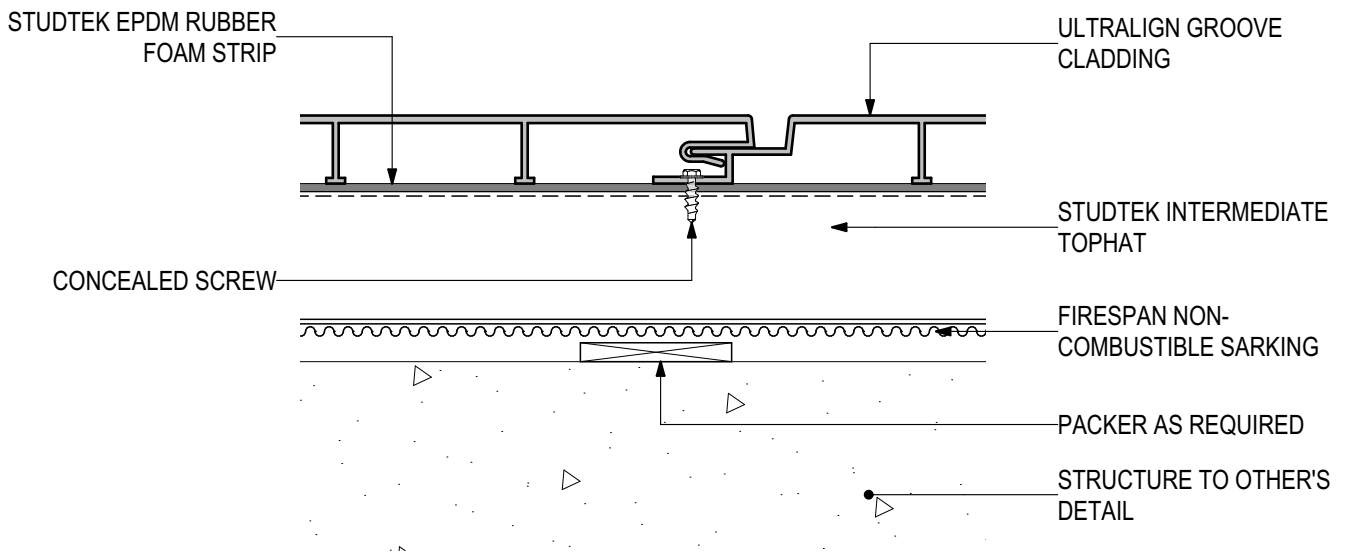

D.01 - TYPICAL FIXING DETAIL

SCALE 1:2

Disclaimer: These details are general design details for use as a guide.
Any use is at their own discretion and risk.

ULTRALIGN Groove Aluminium Cladding System UL-GR-CSF Concealed Screw Fix

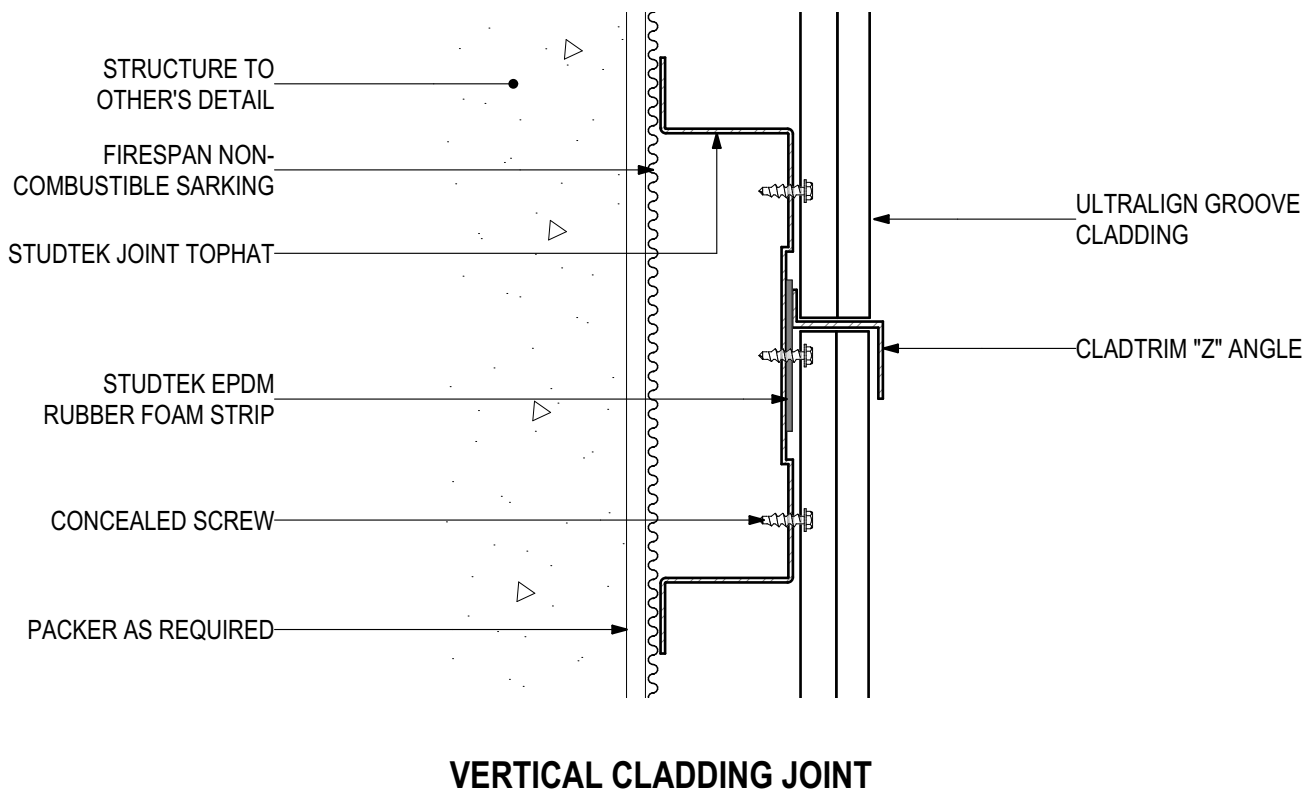
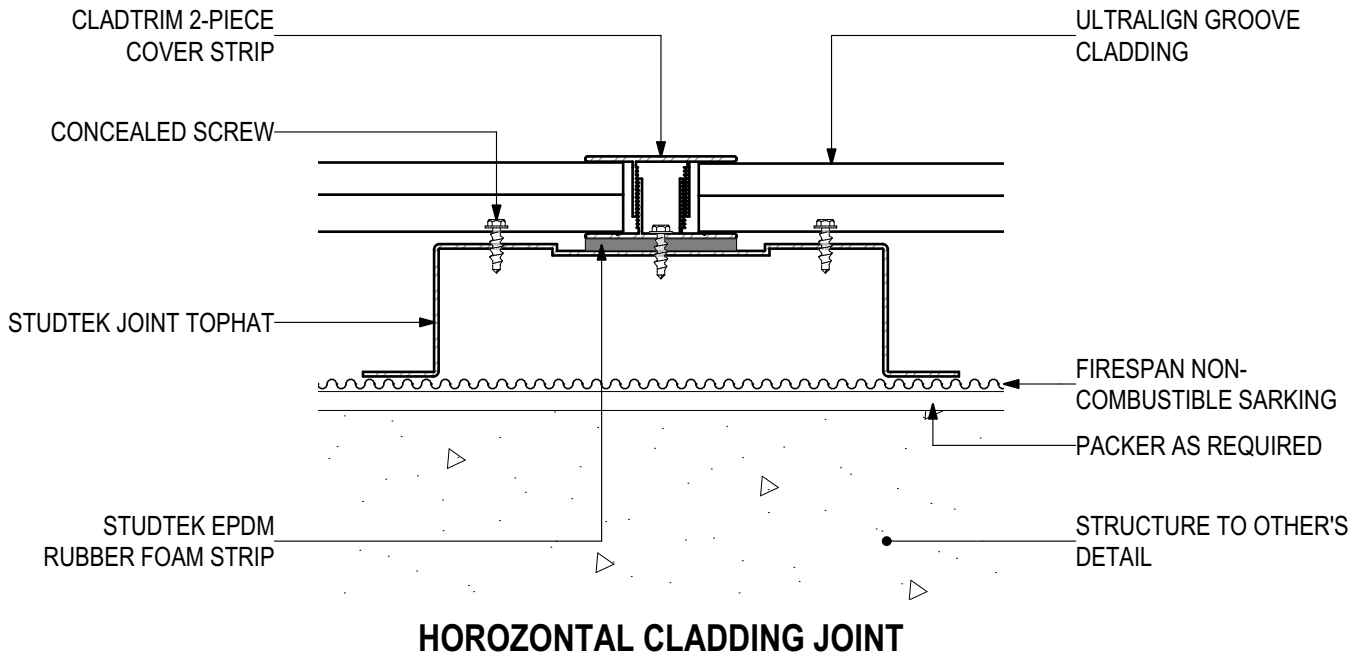

D.02 - JOINT DETAILS

SCALE 1:2

Disclaimer: These details are general design details for use as a guide. Any use is at their own discretion and risk.

ULTRALIGN Groove Aluminium Cladding System UL-GR-CSF Concealed Screw Fix

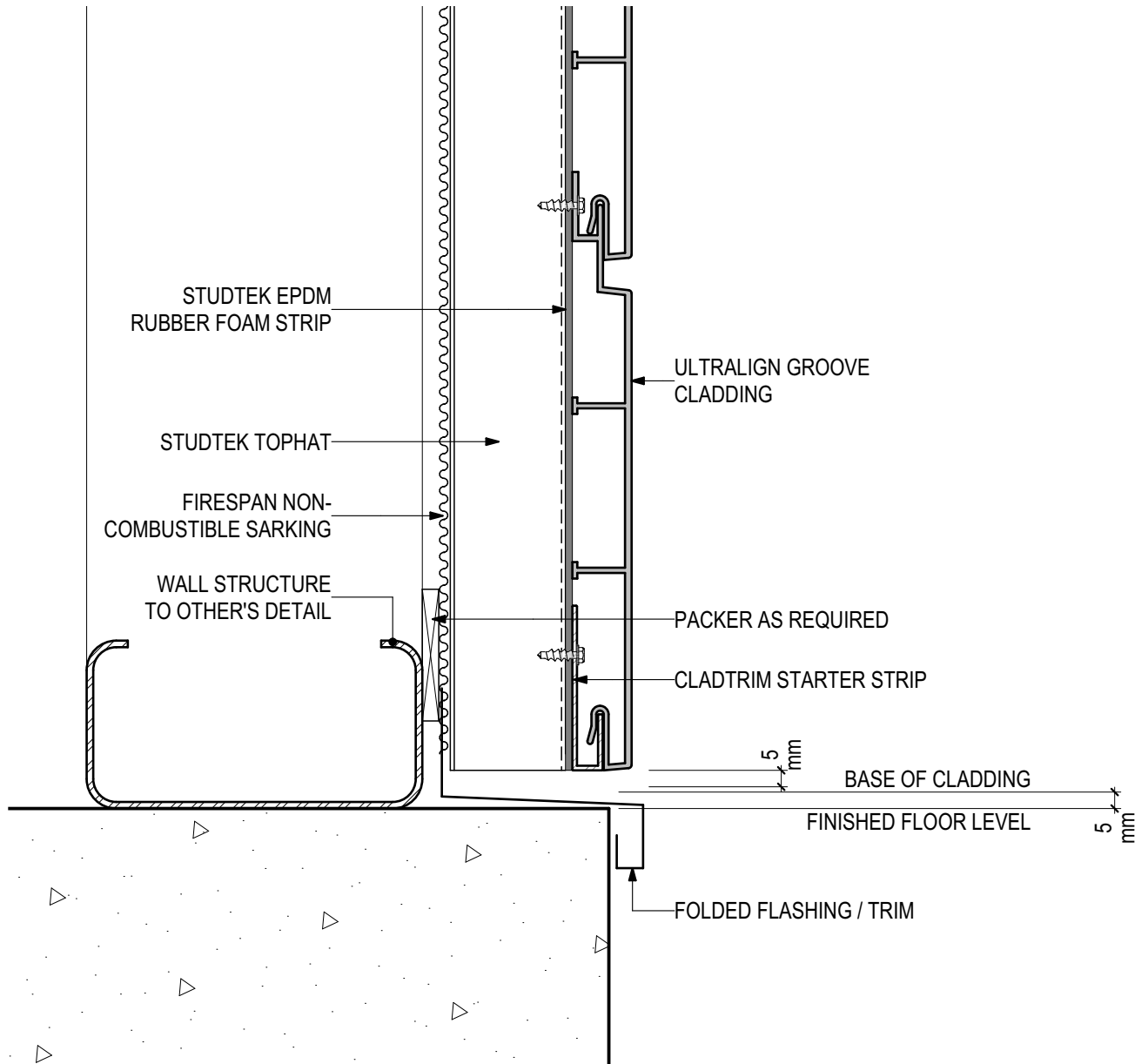

D.03 - BASE DETAIL

SCALE 1:2

Disclaimer: These details are general design details for use as a guide. Any use is at their own discretion and risk.

ULTRALIGN Groove Aluminium Cladding System UL-GR-CSF Concealed Screw Fix

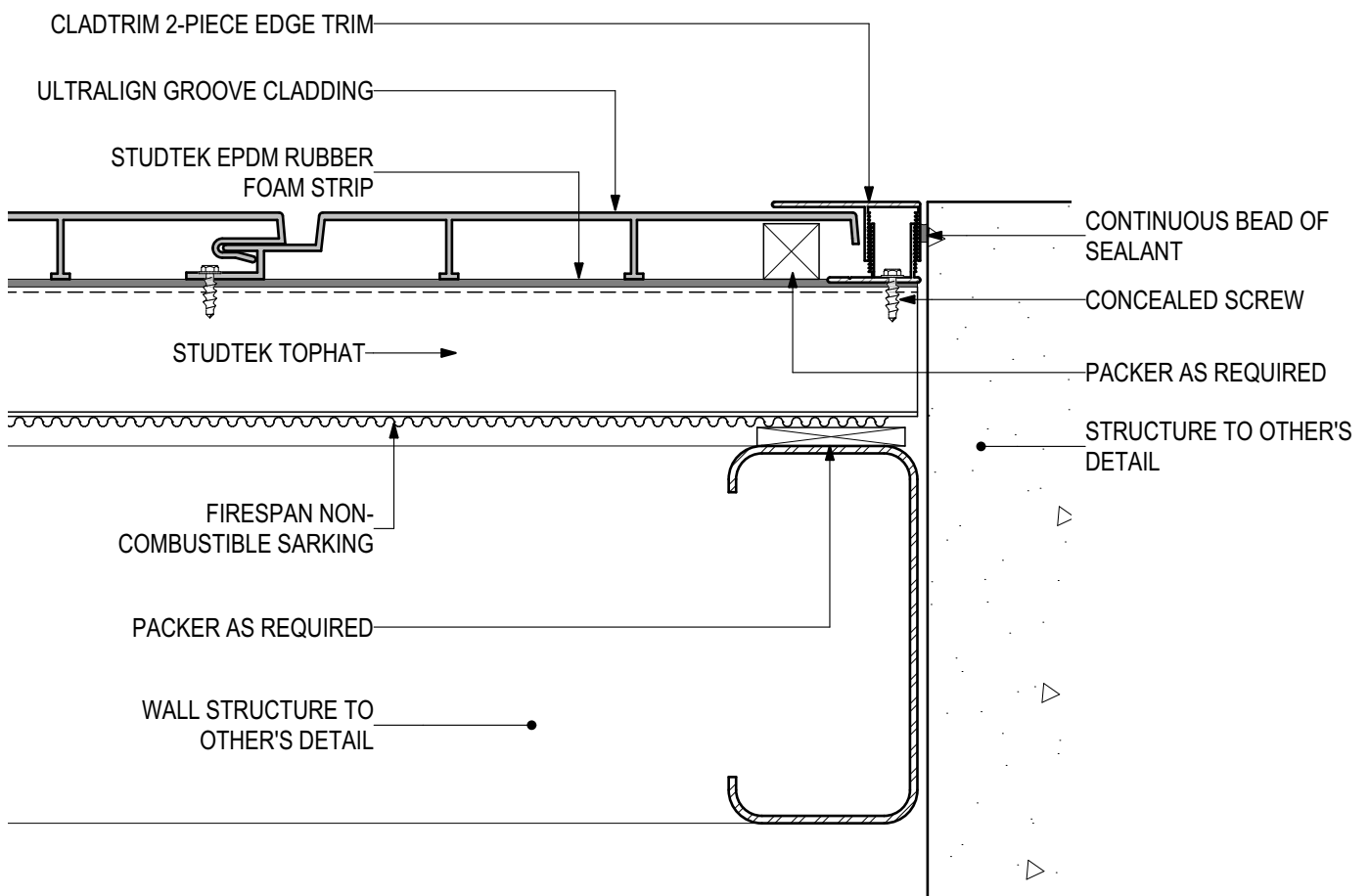

D.04 - WALL ABUTMENT

SCALE 1:2

Disclaimer: These details are general design details for use as a guide. Any use is at their own discretion and risk.

ULTRALIGN Groove Aluminium Cladding System UL-GR-CSF Concealed Screw Fix

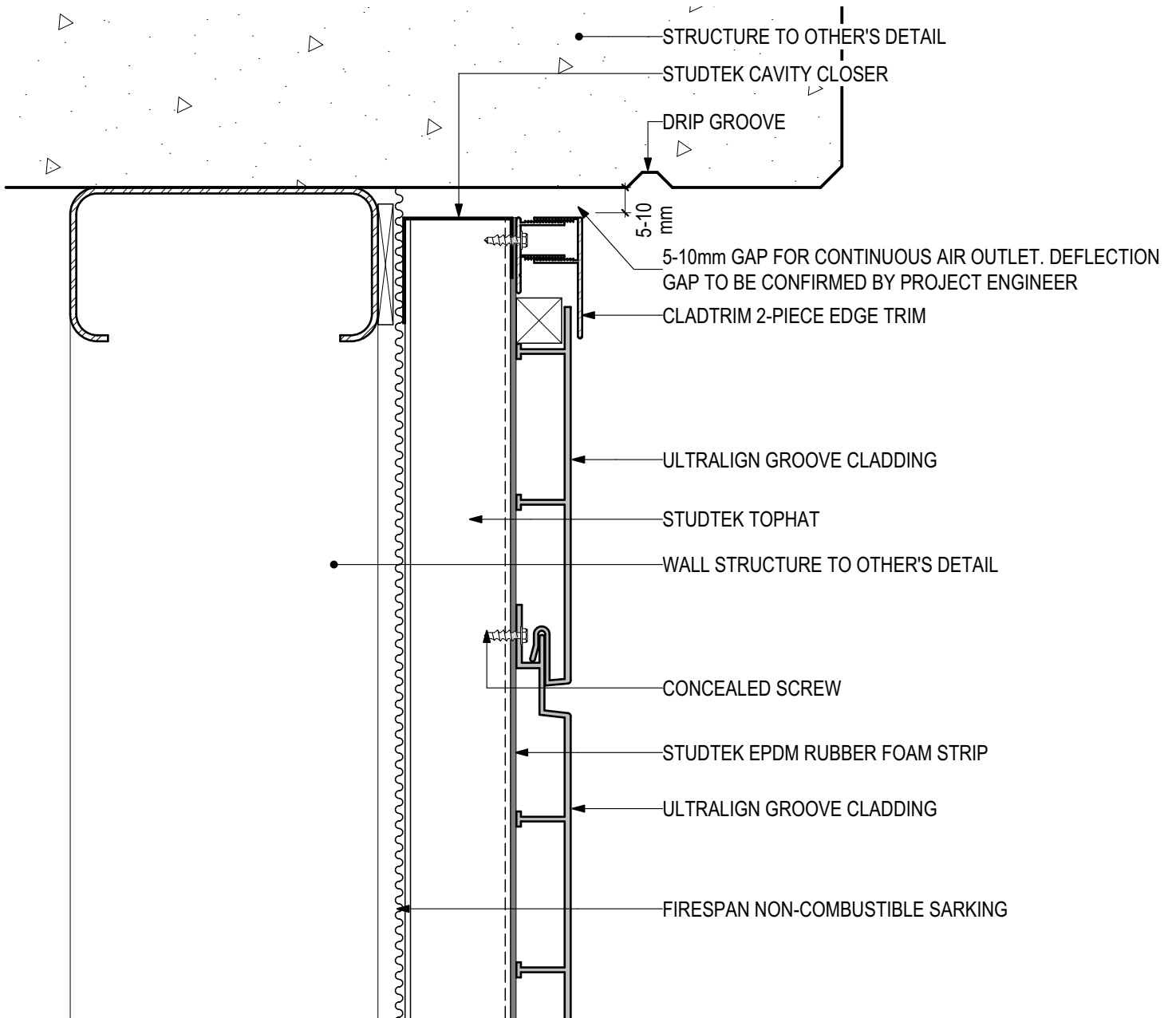

D.05 - HEAD AT SLAB JUNCTION

SCALE 1:2

Disclaimer: These details are general design details for use as a guide. Any use is at their own discretion and risk.

ULTRALIGN Groove Aluminium Cladding System UL-GR-CSF Concealed Screw Fix

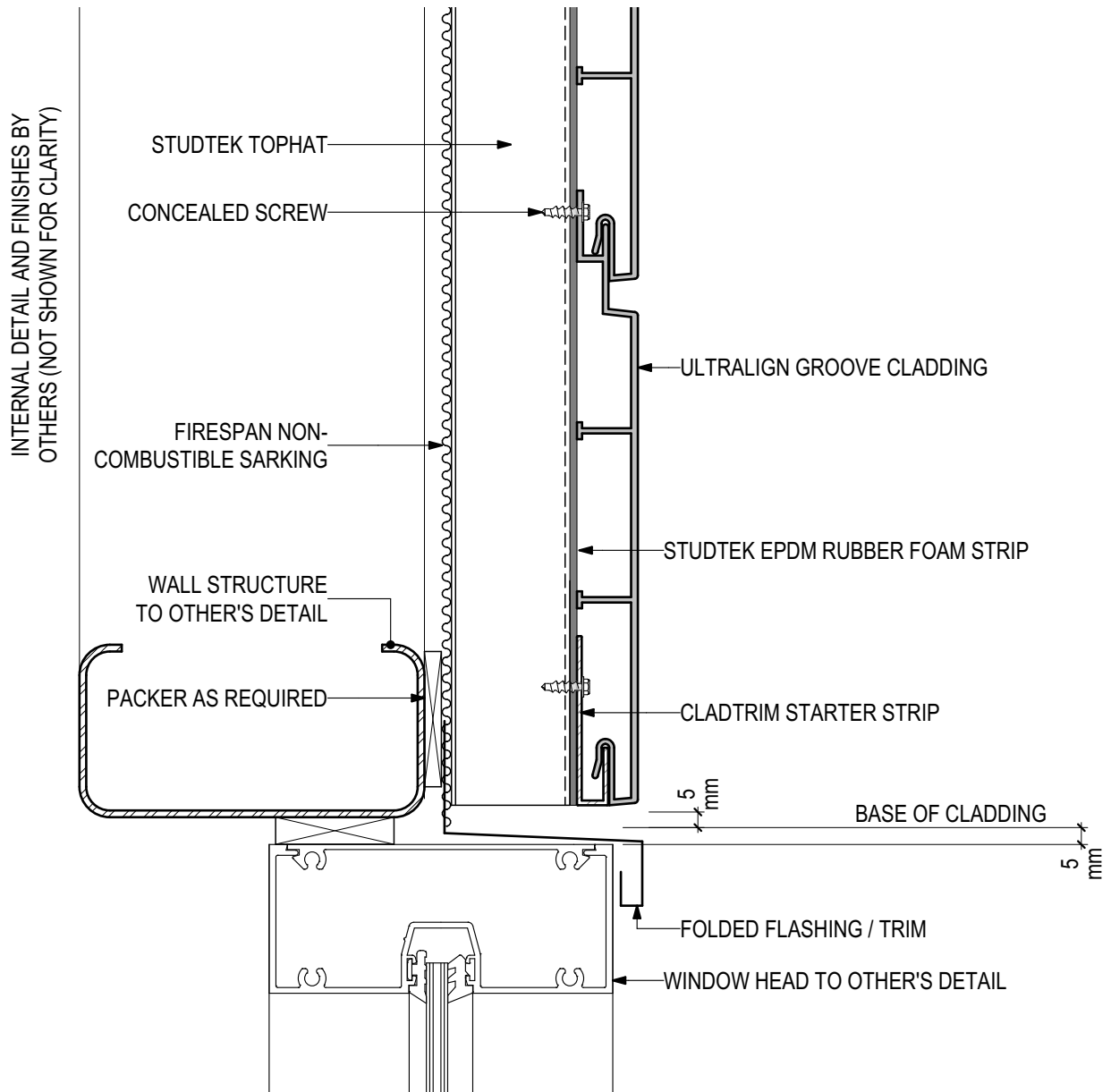

D.06 - WINDOW HEAD

SCALE 1:2

Disclaimer: These details are general design details for use as a guide. Any use is at their own discretion and risk.

ULTRALIGN Groove Aluminium Cladding System UL-GR-CSF Concealed Screw Fix

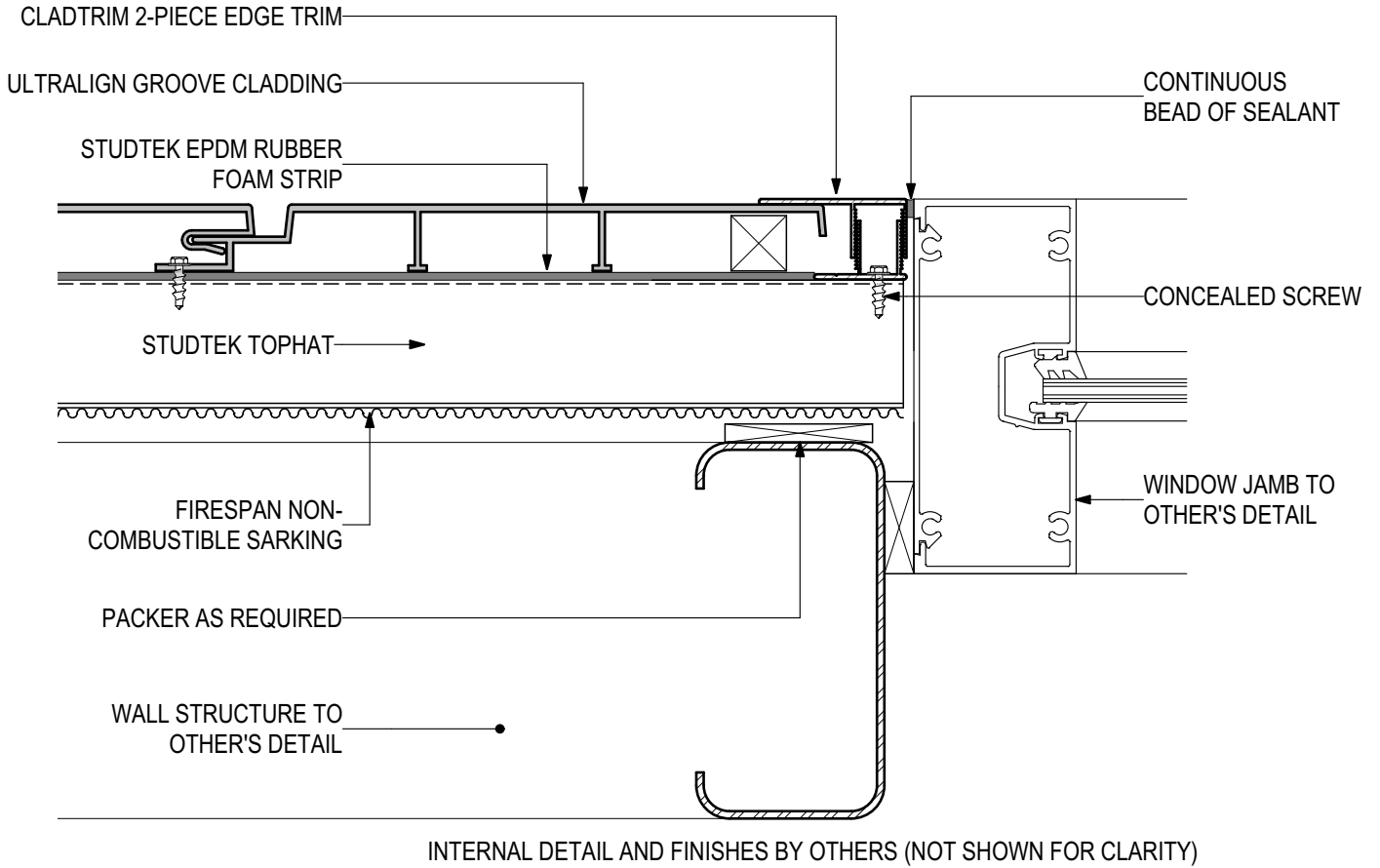

D.07 - WINDOW JAMB

SCALE 1:2

Disclaimer: These details are general design details for use as a guide. Any use is at their own discretion and risk.

ULTRALIGN Groove Aluminium Cladding System UL-GR-CSF Concealed Screw Fix

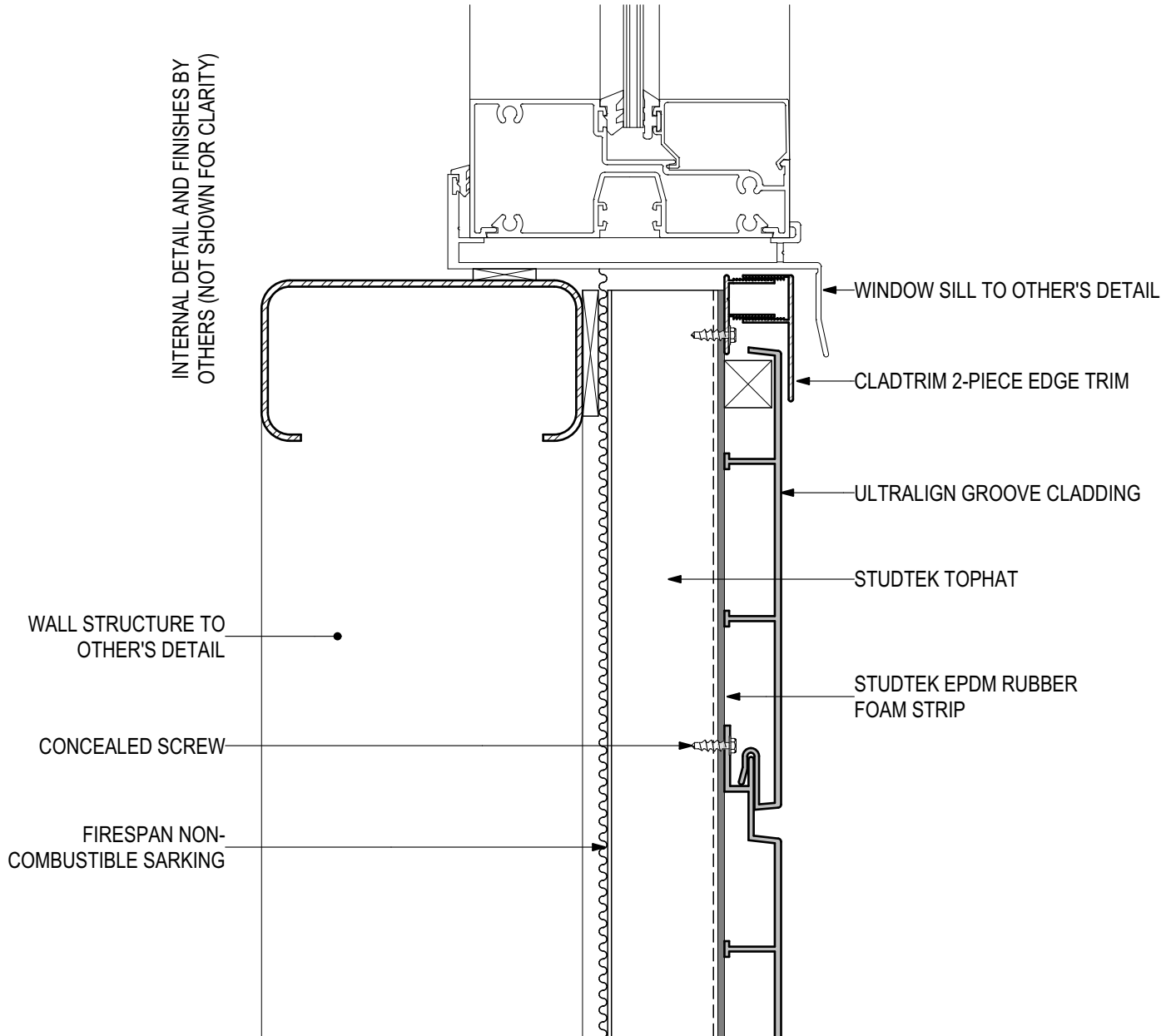

D.08 - WINDOW SILL

SCALE 1:2

Disclaimer: These details are general design details for use as a guide. Any use is at their own discretion and risk.

ULTRALIGN Groove Aluminium Cladding System UL-GR-CSF Concealed Screw Fix

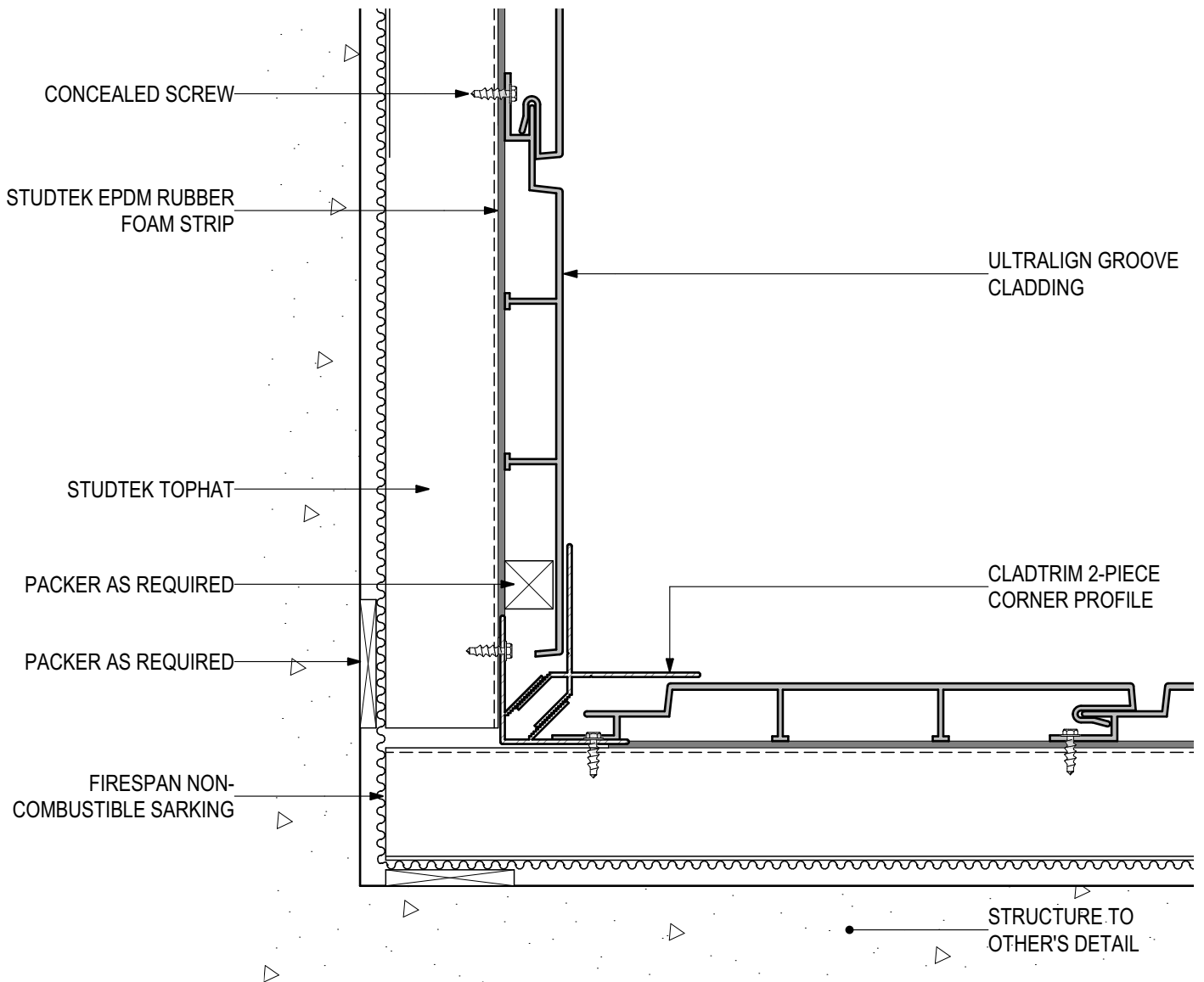

D.09 - INTERNAL CORNER

SCALE 1:2

Disclaimer: These details are general design details for use as a guide. Any use is at their own discretion and risk.

ULTRALIGN Groove Aluminium Cladding System UL-GR-CSF Concealed Screw Fix

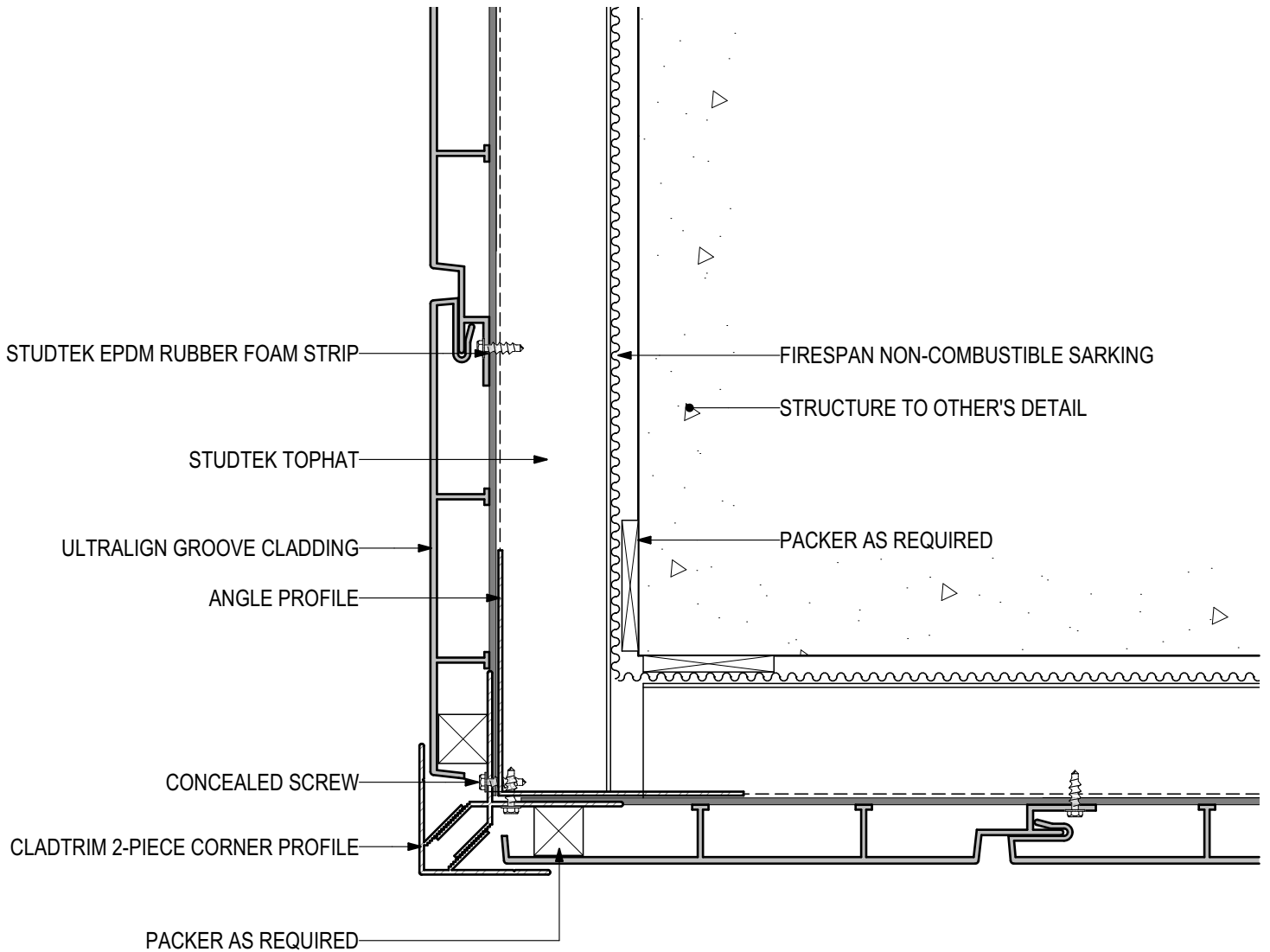

D.10 - EXTERNAL CORNER

SCALE 1:2

Disclaimer: These details are general design details for use as a guide. Any use is at their own discretion and risk.

ULTRALIGN Groove Aluminium Cladding System UL-GR-CSF Concealed Screw Fix

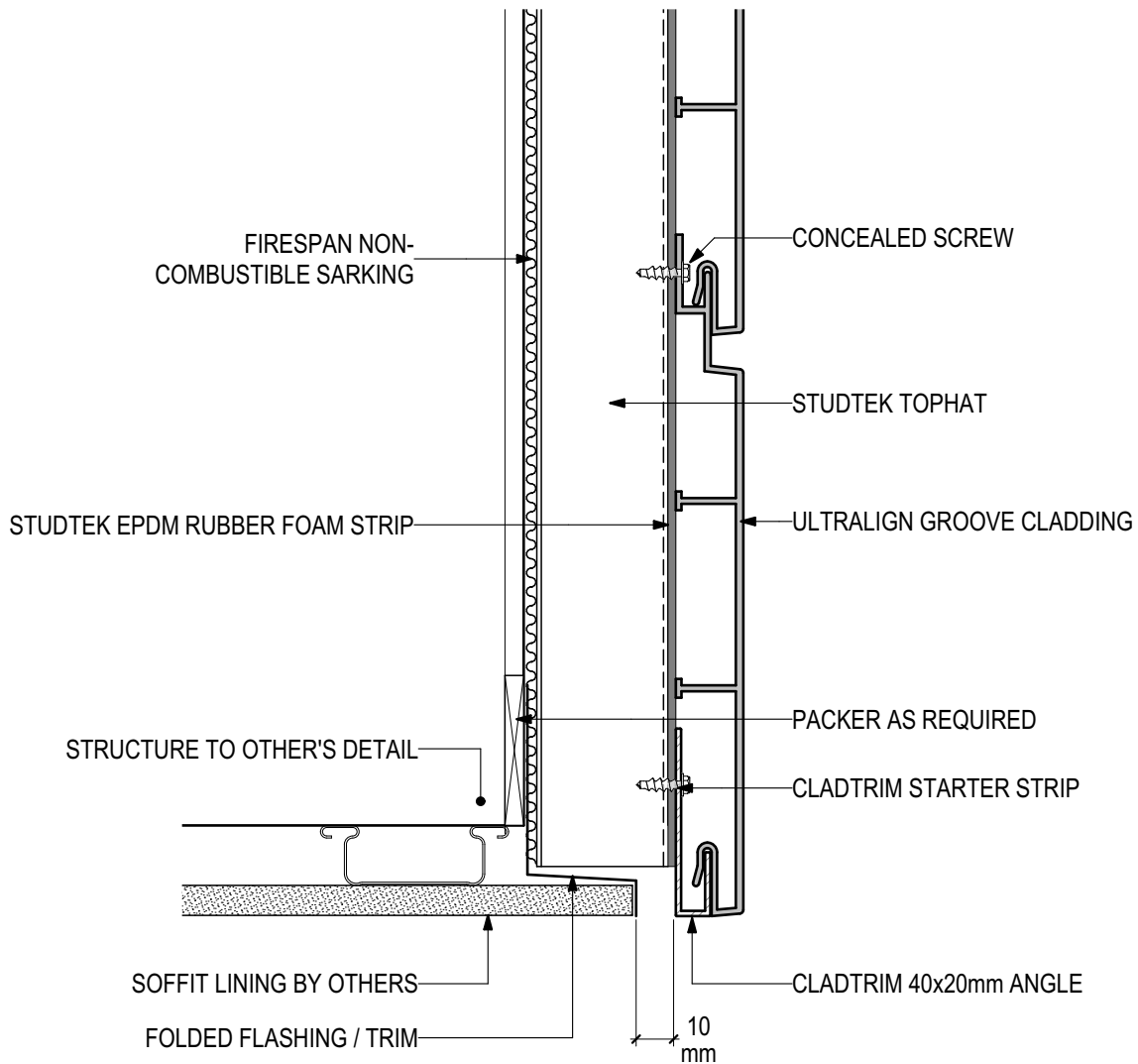

D.11 - SOFFIT JUNCTION

SCALE 1:2

Disclaimer: These details are general design details for use as a guide. Any use is at their own discretion and risk.

ULTRALIGN Groove Aluminium Cladding System UL-GR-CSF Concealed Screw Fix

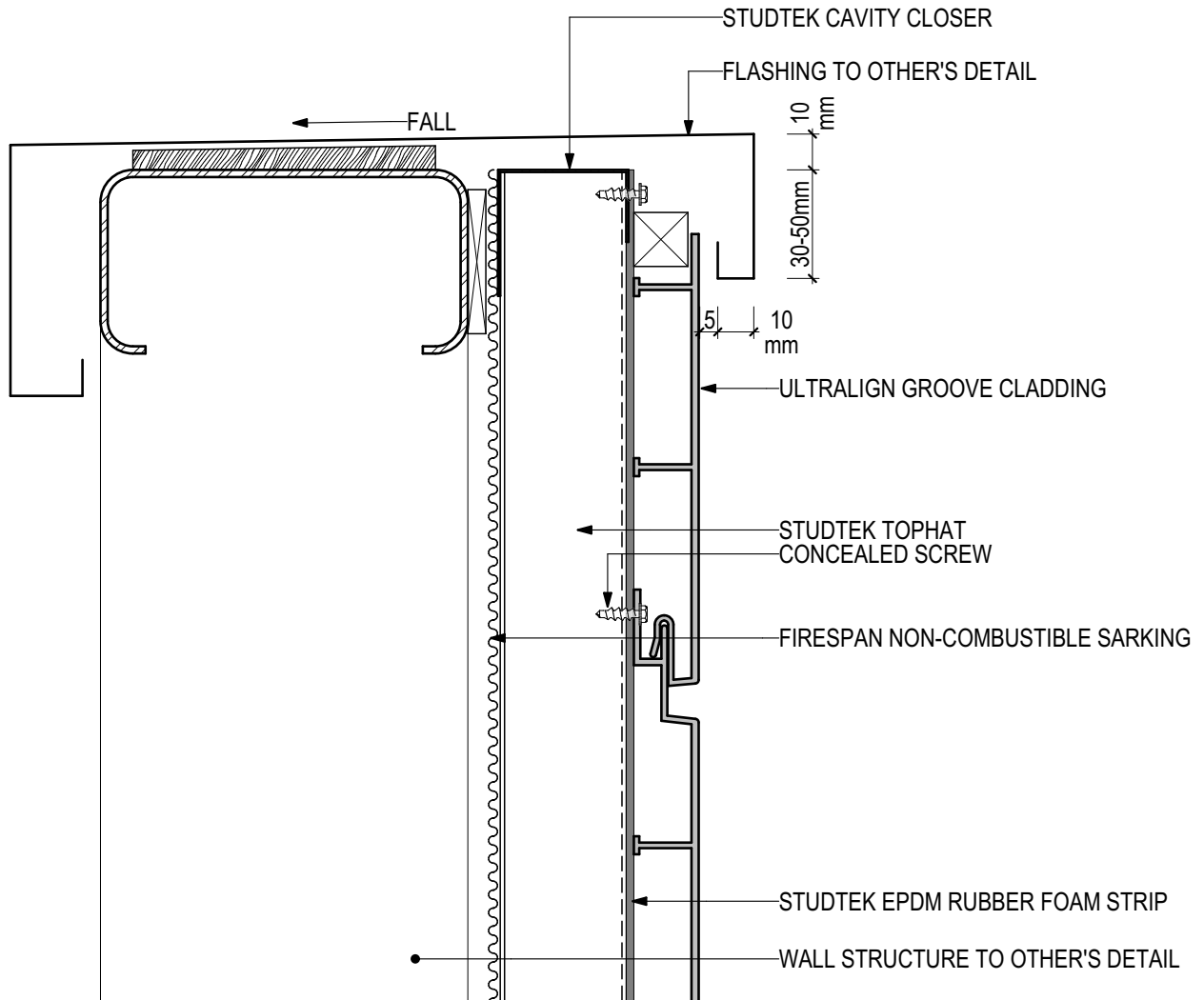

D.12 - PARAPET DETAIL

SCALE 1:2

Disclaimer: These details are general design details for use as a guide. Any use is at their own discretion and risk.

ULTRALIGN Groove Aluminium Cladding System UL-GR-CSF Concealed Screw Fix

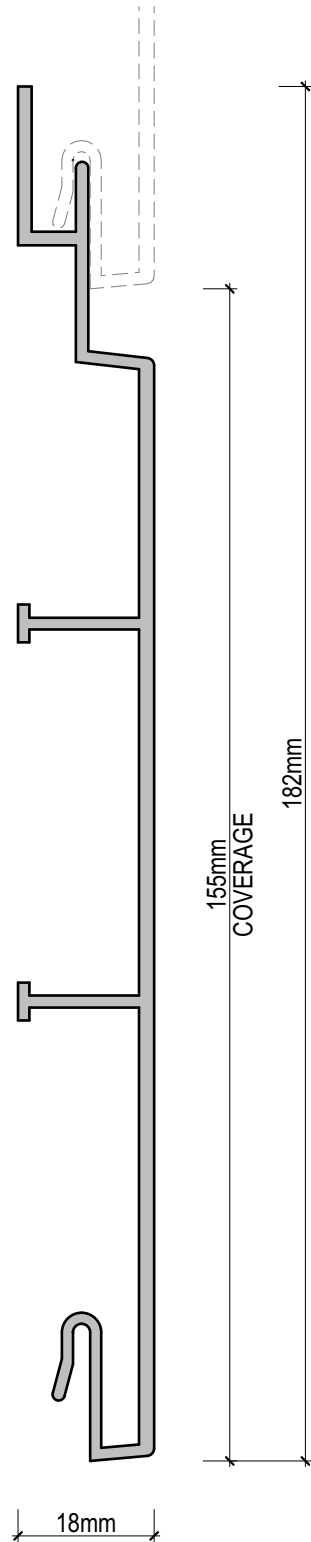

ULTRALIGN GROOVE PROFILE (ULG155)

SCALE 1:1

Disclaimer: These details are general design details for use as a guide. Any use is at their own discretion and risk.