

TECHNICAL MANUAL

ULTRACORE IQ Intelligent Non-combustible Core Panel

1. Introduction
2. Quality Control
3. Physical Properties
4. Fire Performance
5. Coating Performance
6. Fabrication & V-grooving
7. Installation & Span Tables
8. Miscellaneous

1.1 About This Manual:

This manual has been developed to effectively assist fabricators and contractors to work with ULTRACORE IQ. Due to the uncontrollable conditions onsite and different methods of job scope, as well as the variable skills and judgment of installers and the quality of equipment, tools, etc, the suggestions and recommendations contained in this manual are provided without warranty. The information and recommendations herein are believed to be correct at time of publishing.

BLUECHIP reserves the right to revise the contents of this manual without prior notice. Any construction or use of the product must be in accordance with all local zoning and/or building codes and in accordance with the current NCC at the time of use. Except as contained in a written warranty certificate, the supplier does not provide any other warranty, either express or implied, and shall not be liable for any damages, including consequential damages.

1.2 Company Background:

Founded in 2003 by five brothers, BLUECHIP has grown every year since to become one of Australia's leading suppliers of architectural building envelopes. BLUECHIP's product range covers the complete system from the structure out including all types of cladding materials, composite decking, sub-framing, insulation, waterproofing and fixings.

With offices in Sydney, Melbourne and Perth, BLUECHIP has supplied more than 3,000,000m² of materials to Australian projects since 2003. Our commitment to innovation and ongoing investment in R&D ensures BLUECHIP will continue to lead the market with BCA/NCC compliant facade solutions in the years ahead.

For architects and consultants, BLUECHIP's wide range of different materials and 'complete-system' approach enables the creation of inspiring high-performance facades. For builders and contractors, BLUECHIP's large local stock, well established supply chains and genuine appreciation for our clients means you can trust us to deliver as promised every time.

1.3 Company Details:

Company: Blue Chip Group Pty Ltd
ABN: 98 162 282 064
Head Office: 16 Ashby Close, Forrestfield WA 6058
Phone: 1300 945 123
Email: sales@bluechipgroup.net.au



1.4 Product Description:

ULTRACORE IQ intelligent core panel is Deemed-to-Satisfy non-combustible when tested to AS 1530.1 and AS 1530.3 as per the requirements of the NCC 2022, Clause C2D10(6)(g) and installed using the mechanical cassette-fix system as per NCC 2022, Clause C2D15(1). It has also been tested to BS 8414 and AS 5113 full-scale testing to prove it does not contribute to the spread of fire. Visually, ULTRACORE IQ intelligent non-combustible core panel looks the same as traditional aluminium composite panel but with zero combustible core content (0%) meaning it achieves the lowest risk rating, category D, from the Insurance Council of Australia.

Proven V-Groove Durability

Unlike SOLID aluminium panels, ULTRACORE IQ can demonstrate 40 years of proven corner durability when using the common v-groove folding system. This is because the front skin is not impacted when v-grooving.

AS 1530.1 Non-Combustible

ULTRACORE IQ is one of the few aluminium panels globally that is Deemed-to-Satisfy non-combustible when tested to AS 1530.1 and AS 1530.3 in accordance with the NCC 2019 Clause C1.9(e)(vii) requirements.

AS 5113 Fire Testing

ULTRACORE IQ is Deemed-to-Satisfy non-combustible so does not require further testing however it has been tested to AS 5113 full-scale testing by Exova Warringtonfire to prove it does not contribute to the spread of fire.

Zero Polyethylene Core (0%)

Unlike most other aluminium panel products including FR, Plus, A2 and NC type panels, the ULTRACORE IQ aluminium core contains ZERO percent flammable polyethylene (0%) and each lamina is 100% non-combustible.

Less Thermal Conductivity

ULTRACORE IQ aluminium core panel has a thermal conductivity of 2.54 W/mK compared to 205 W/mk for a SOLID aluminium panel. This means 80 x slower rate of heat transfer for greater fire safety and section J compliance.

Mechanical Cassette-Fixing

Compared to a SOLID aluminium panel, ULTRACORE IQ is faster and easier to fabricate using the well proven z-angle mechanical cassette-fix system making it more cost effective and compliant with NCC 2022, Clause C2D15(1).

Oil-Canning Resistance

Oil-canning is the uneven distribution of tension in SOLID aluminium panels which results in a rippling effect on the facade. The superior mechanical properties of ULTRACORE IQ guarantees against oil-canning.

Less Carbon Footprint

ULTRACORE IQ intelligent core panel is 100% recyclable and uses 50% less aluminium per m² than 3mm SOLID aluminium for much less carbon footprint. It is also 50% lighter for significant structural and labour savings.

1.5 More Information:

<https://www.bluechipgroup.net.au/facade-cladding-perth/non-combustible-cladding-perth.html>



2.1 Manufacturing Quality:

A dedication to the total fulfillment of our client's expectations is reflected by a complete quality control system, beginning at the point of specification, and continuing through to delivery of the guaranteed products. All activities are carried out in a manner which:

- Uses the framework of ISO9000 Quality Standards to verify the quality of our systems
- Ensures that our products and services are of the highest standards
- Creates continuous improvements to our product and processes through the application of the best quality practices.

2.2 Acceptable Tolerances:

Panel Width:	+/- 3.0mm
Panel Length:	+/- 5.0mm
Thickness:	+/- 2.0%
Bow Allowed:	<0.5%
Squareness:	<5.0mm
Surface Defects:	In accordance with AAMA 2605-05

2.3 Product Warranty:

The standard product warranty is 10 years, with longer warranties available on a project specific basis. The supplier excludes all warranties in relation to the goods except for those provided in a Warranty Certificate provided to the Customer by the supplier in relation to the Goods.

A project specific full-system warranty may be available if the product is supplied with all recommended system components and fabricated and installed by a licensed installer accredited and approved by BLUECHIP in writing.

3.1 Panel Composition

1. PVDF Coil Coating System
2. 0.7mm Aluminium Face Skin
3. <0.1mm Dry-film Adhesive
4. 2.6mm Aluminium IQ Core
5. <0.1mm Dry-film Adhesive
6. 0.5mm Aluminium Rear Skin
7. Polyester Anti-corrosion Coating

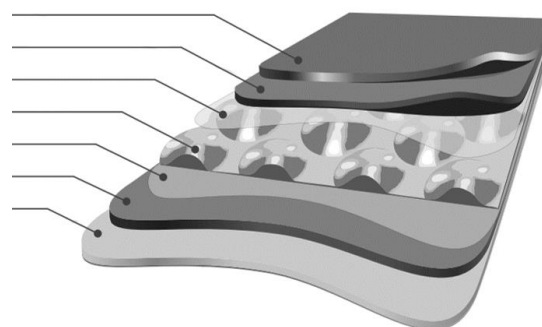

3.3 Core Composition:

Each lamina of ULTRACORE IQ including the 0.7mm face skin, the 2.6mm profiled core and the 0.5mm rear skin is made from 100% aluminium with zero percentage of combustible content.

Unlike FR, A2 and NC type cores, the ULTRACORE IQ aluminium core does not rely on flammable polymers for its mechanical integrity so it can offer both superior fire safety as well as superior resistance to core delamination over time with much higher bond peel strength.



3.3 Technical Data – Physical Properties:

ITEM	TEST STANDARD	UNIT	RESULT
Thickness	Actual	mm	4.0
Panel Weight	Actual	Kg/m ²	4.2
Face Skin Thickness	Actual	mm	0.7
Rear Skin Thickness	Actual	mm	0.5
Adhesive Thickness per Layer	Actual	mm	<0.1
Adhesive Total Thickness	Actual	mm	<0.2
Bond Peel Strength	ASTM D1781-98	N/mm	>270
Tensile Strength (Skins)	ASTM E8	MPa	>160
Thermal Conductivity	ASTM C-518	W/mK	<3.0
Thermal Expansion	Actual	mm/m/°C	0.025
Alloy Grade / Temper	Actual	-	3003 H14
Standard Sheet Sizes			
▪ 2500 x 1500mm	Actual	m ²	3.75
▪ 3200 x 1500mm	Actual	m ²	4.80
▪ 4000 x 1500mm	Actual	m ²	6.00
Non-stock Sizes (600m ² MOQ)			
▪ 2500 x 1250mm	Actual	m ²	3.125
▪ 3200 x 1250mm	Actual	m ²	4.00
▪ 4000 x 1250mm	Actual	m ²	5.00

4.1 Deemed-to Satisfy Non-combustible:

ULTRACORE IQ cassette-fixed panels are deemed-to-satisfy (DTS) non-combustible as per the requirements of NCC 2019, clause C1.9(e)(vii) and NCC 2022, clause C2D10(6)(g) and C2D15(1) for use on any building of types A, B & C construction, classes 2-9.

4.2 Technical Data – Fire Performance:

ITEM	TEST STANDARD	UNIT	RESULT
Non-combustible	AS 1530.1	CSIRO	Pass
Non-combustible (DTS) – 2019	NCC C1.9(e)(vii)	CSIRO	Pass
Non-combustible (DTS) – 2022	NCC C2D10(6)(g)	CSIRO	Pass
Ignitability Index	AS 1530.3	CSIRO	0
Spread of Flame Index	AS 1530.3	CSIRO	0
Heat Evolved Index	AS 1530.3	CSIRO	0
Smoke Developed Index	AS 1530.3	CSIRO	1
Full-scale Temperature Results*			
▪ 5m External (50mm)	AS 5113	<600°C	Pass
▪ 5m Panel Cavity	AS 5113	<250°C	Pass
▪ 5m Framing Cavity	AS 5113	<250°C	Pass
▪ 0.9m Unexposed	AS 5113	<180°C	Pass
Full-scale Flaming Criteria*	AS 5113	No Flaming	Pass
Full-scale Openings Criteria*	AS 5113	No Openings	Pass
Full-scale Spread-of-Flame*	AS 5113	No Spread	Pass

*Although NOT required for compliance, ULTRACORE IQ has been tested to BS 8414 and AS 5113 full-scale testing to prove it does not contribute to the spread fire. It also significantly outperforms 3mm SOLID aluminium in all AS 5113 temperature and debris criteria.



5.1 Paint Systems:

ULTRACORE IQ panels use only PVDF Kynar 500 or FEVE fluoropolymer-based paint systems applied using continuous coil coating. These paint systems are known for their high durability and optimum resistance to weather and industrial pollution. More than 40 years of use globally confirms the superior chemical and physical properties of fluoropolymer coatings.

ULTRACORE IQ coatings are applied in accordance with AAMA 2605-05, the internationally recognised paint standard for architecturally finished aluminium.

5.2 Technical Data – PVDF Kynar 500 Coating Properties:

ITEM	TEST STANDARD	UNIT	RESULT
Aluminium Substrate	ASTM D1005	-	Pass
Coating Flexibility	ASTM D4145	2T	Pass
Dry Film Thickness <ul style="list-style-type: none"> ▪ Primer Coating ▪ Coloured Coating ▪ Clear Coating (If applicable) 	ASTM D1400 ASTM D1400 ASTM D1400	Mil Mil Mil	0.2-0.3 0.7-0.8 0.3-0.4
Colour Difference	ASTM 2244	4000hrs	DE<5
Gloss Retention	ASTM 2244	4000hrs	85%
Chalking Resistance	ASTM 2244	4000hrs	<8
Pencil Hardness	ASTM D3363	-	HB
Dry Film Adhesion	Actual	38°C, 24hrs	Pass
Wet Film Adhesion	Actual	100°C, 24hrs	Pass
Reverse Impact Adhesion	ASTM D3359	1/16	Pass
Bending / Gardener Impact	ASTM D3281	-	Pass
Salt Resistance <ul style="list-style-type: none"> ▪ 5% Salt Spray @ 95°F ▪ Gloss Reduction ▪ Colour Change ▪ Chalk Resistance 	ASTM B117 ASTM D523 ASTM 2244 ASTM 4214	4000hrs 5000hrs 5000hrs 5000hrs	Pass 0.8% DE=0.68 Pass
Humidity Resistance <ul style="list-style-type: none"> ▪ 100% RH @ 95°F ▪ Gloss Reduction ▪ Colour Change ▪ Chalk Resistance 	ASTM B117 ASTM D523 ASTM 2244 ASTM 4214	4000hrs 5000hrs 5000hrs 5000hrs	Pass 0% DE=0.52 Pass
Weather Resistance <ul style="list-style-type: none"> ▪ Exterior Exposure @ 45° ▪ Gloss Reduction ▪ Colour Change ▪ Chalk Resistance 	South Florida ASTM D523 ASTM 2244 ASTM 4214	10 years 5000hrs 5000hrs 5000hrs	Pass 6.2% DE=0.27 Pass
Chemical Resistance <ul style="list-style-type: none"> ▪ Mortar Test ▪ Gloss Reduction ▪ Colour Change 	ASTM C207 ASTM D523 ASTM 2244	24hrs 16hrs 16hrs	Pass 6.2% DE=0
Solvent Resistance - MEK	ASTM 2794	Double Rub	Pass
Acid Resistance – 10% H ₂ SO ₄	ASTM 1308	7 days	Pass
Alkali Resistance – 10% NaOH	ASTM 1308	7 days	Pass
Detergent Resistance – 3%	ASTM D2248	72hrs	Pass



6.1 V-grooving:

V-grooving ULTRACORE IQ to fabricate cassette panels is a simple and easy process, very similar to v-grooving traditional ACP such as ULTRABOND FR. Traditionally ACP with a solid core and 0.5mm face skin is grooved to leave approximately 0.3mm of core material remaining with total material remaining of 0.8mm (0.5mm face skin + 0.3mm of core).

The recommended overall depth for v-grooving ULTRACORE IQ is the same or slightly less than traditional ACP to leave between 0.8-0.9mm of total material remaining including the 0.7mm face skin and up to 0.1mm of adhesive and 0.1mm of the profiled aluminium core. For best results route to 0.8mm depth removing all the aluminium core and only leaving the 0.7mm face skin and the 0.1mm adhesive layer at the base of the groove.

It is important to leave a minimum 0.1mm of adhesive / core material at the base of the groove (0.8mm total material) so that the 0.7mm face skin is not touched by the router bit to ensure its inherent mechanical strength and structural integrity is retained.

Like standard ACP, a 90-degree v-groove router bit should be used with a minimum 3.0mm flat at the base of the v-groove.

MACHINE	TOOLING	DEPTH	M/Min
CNC Router (Recommended)	90° with a flat 3.0mm wide base	Min 0.8mm of material remaining	10-15
Wall Saw or Portable Saw	Same as above	Same as above	10-15

6.2 Cutting:

ULTRACORE IQ can be cut with identical tooling to that used for ULTRABOND FR and similar ACP's. For CNC router machines, an up-spiral cutter is recommended to assist with swarf removal. There is no coolant required on the cutter or v-groove tooling when fabricating ULTRACORE IQ panels.

6.3 Curved Panels:

ULTRACORE IQ can be formed to create curved panels to a minimum radius of approximately 1m. Use a suitable rolling machine to roll 38 x 19 x 3mm RHS stiffeners to the required radius before attaching the ULTRACORE IQ panel to the stiffeners with 2 continuous strips of 12mm wide TESA 7044 ACXplus double-sided tape and a suitable structural adhesive to form a curved cassette panel which is then mechanically fixed onsite.

6.3 Edge Close-out Methods:

Acceptable edge close-out methods are as below;

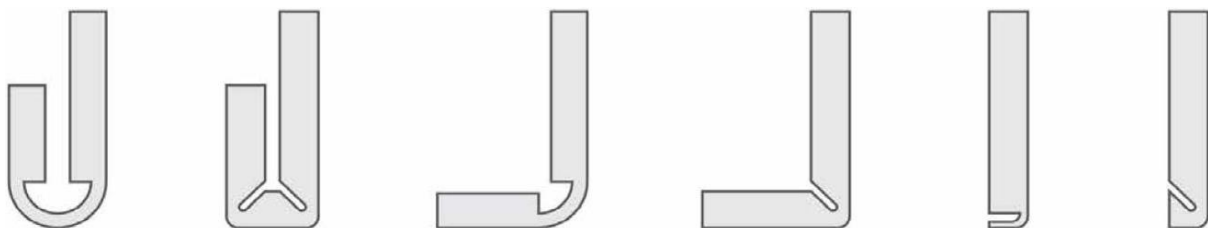



7.1 Installation:

Mechanical cassette-fix installation is the recommended installation system for ULTRACORE IQ cladding using the well-proven v-groove 'route & return' fabrication method with offset aluminium z-angles as per the below detail. It is also acceptable to install ULTRACORE IQ in a glazing suite for curtain wall application. Both these methods comply with the requirements of NCC 2022, Clause C2D15(1). Tape-fix installation is not recommended as it does not comply.

Installation Details:

The panels shall be fabricated and installed in accordance with the most recent version of the ULTRACORE IQ Installation Details which are available online at www.bluechipgroup.net.au or by emailing sales@bluechipgroup.net.au or by calling **1300 945 123**. (Only PDF installation details are available online. For CAD/DWG installation details email or call as above).

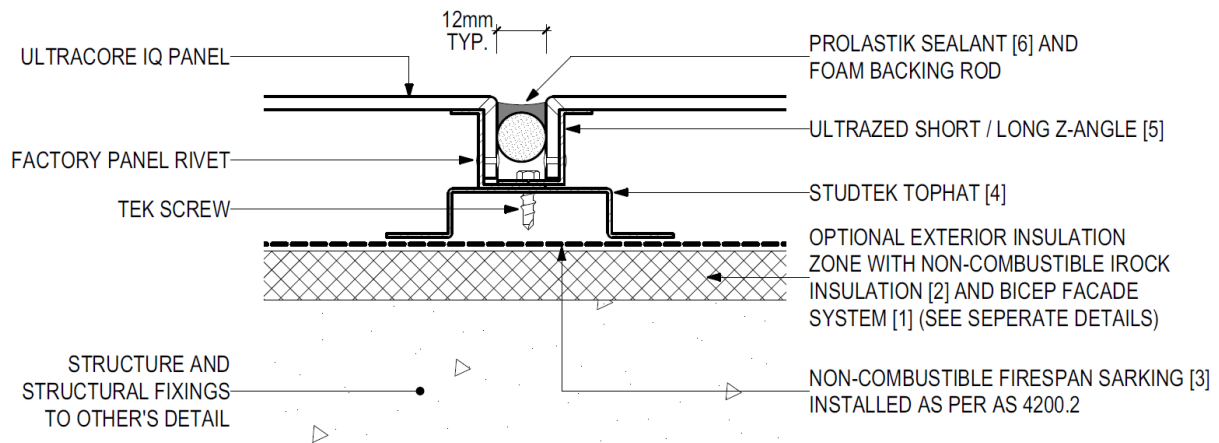

7.2 Acceptable System Components:

Insulated Façade System - OPTIONAL:

For an optional insulated façade system use BICEP façade brackets and support profiles with IROCK non-combustible insulation to achieve an engineered exterior insulation zone.



Sarking:

In climate zones 1-3, sarking shall be FIRESARK DTS non-combustible vapour barrier and in climate zones 4-8, sarking shall be FIRESARK Class 4 vapour permeable membrane, as per the requirements of NCC 2022 clause F8D3. Install and tape sarking in accordance with AS 4200.2 behind all cladding areas for DTS weatherproofing compliance as per NCC 2022 clause F3D3.

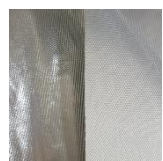

Sub-framing System:

The sub-framing system shall be STUDTEK steel top-hats attached to the main structure (or BICEP Façade System) in a manner to ensure all applied loadings to the cladding is transferred back to the main structure. Size and spacing of top hat members shall be determined according to applied loads and deflection limitations for any given project. Top-hat centres shall be maximum 600mm or installed in a matrix layout to provide full perimeter support to each panel as required to adequately support the cladding system.



Aluminium Z-angle Profiles:

Shall be ULTRAZED extruded aluminium alloy AA 6063-T5 supplied by Blue Chip Group Pty Ltd. The long z-angle shall be powder-coated to avoid bimetallic corrosion with the top-hats.



Panel Joint Sealant:

Panel joints to be sealed with PROLASTIK matt NC silicone sealant supplied by Blue Chip Group Pty Ltd and installed over closed cell foam backing rod to manufacturer's specifications.



Stiffeners & Tape:

As a minimum, the stiffeners shall be ULTRASTIFF 38 x 19 x 3mm RHS (rectangle hollow section) extruded aluminium alloy AA 6063-T5 supplied by Blue Chip Group Pty Ltd. The stiffeners are to be fixed to the back of the ULTRACORE IQ panel using two continuous strips of 12mm wide TESA 7044 ACXplus double-sided tape and a suitable structural adhesive. All stiffeners shall be mechanically fixed to the cassette-fix panel returns at each end in accordance with the manufacturer's install details. Tapes should be applied in accordance with all tape manufacturer's guidelines for preparation and application.





7.3 Span Table Without Stiffeners

Span table is based on the ULTRACORE IQ panels being configured as below.

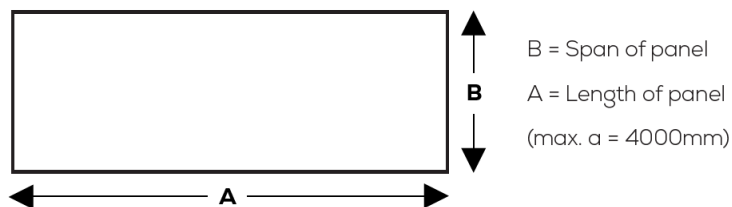

PANEL SPAN			LIMITING WIND PRESSURE (KPA)					Maximum spacing of 5mm rivets along folded edge of perimeter panel (mm)
Panel Width B (mm)	Panel Length A (mm)	Ratio a/b	Correction factors		Ultimate Strength		Serviceability	
			K_s	K_d	Positive Wind Pressure	Negative Wind Pressure	Any direction wind pressure	
400	400	1.0	0.377	0.281	9.000	-9.000	+ 7.768	300
	600	1.5	0.628	0.566	9.000	-9.000	+ 3.851	300
	800	2.0	0.786	0.740	9.000	-9.000	+ 2.946	300
	1000	2.5	0.881	0.841	9.000	-8.528	+ 2.590	300
	1200	3.0	0.942	0.911	9.000	-7.979	+ 2.393	300
600	600	1.0	0.377	0.281	9.000	-8.873	+ 2.302	300
	900	1.5	0.628	0.566	6.485	-5.321	+ 1.141	300
	1200	2.0	0.786	0.740	5.177	-4.248	+ 0.873	300
	1500	2.5	0.881	0.841	4.619	-3.790	+ 0.767	300
	1800	3.0	0.942	0.911	4.322	-73.546	+ 0.709	300
900	900	1.0	0.377	0.281	4.806	-3.944	+ 0.682	300
	1350	1.5	0.628	0.566	2.882	-2.365	+ 0.338	300
	1800	2.0	0.786	0.740	2.301	-1.888	+ 0.259	300
	2250	2.5	0.881	0.841	2.053	-1.685	+ 0.227	300
	2700	3.0	0.942	0.911	1.921	-1.576	+ 0.210	300
1200	1200	1.0	0.377	0.281	2.703	-2.218	+ 0.288	300
	1800	1.5	0.628	0.566	1.621	-1.330	+ 0.143	300
	2400	2.0	0.786	0.740	1.294	-1.062	+ 0.109	300
	3000	2.5	0.881	0.841	1.155	-0.948	+ 0.096	300
	3600	3.0	0.942	0.911	1.080	-0.887	+ 0.089	300
1500	1500	1.0	0.377	0.281	1.730	-1.420	+ 0.147	300
	2250	1.5	0.628	0.566	1.038	-0.851	+ 0.073	300
	3000	2.0	0.786	0.740	0.828	-0.680	+ 0.056	300
	3750	2.5	0.881	0.841	0.739	-0.606	+ 0.049	300
	4000	2.7	0.904	0.866	0.721	-0.591	+ 0.048	300



7.4 Span Table Including Stiffeners

Span table is based on the ULTRACORE IQ panels being configured as below.

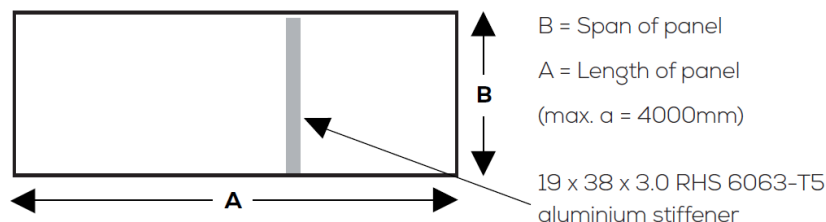

PANEL SPAN			LIMITING WIND PRESSURE (KPA)				Maximum spacing of 5mm rivets along folded edge of perimeter panel (mm)	
Panel Width B (mm)	Panel Length A (mm)	Ratio a/b	Correction factors		Ultimate Strength			Serviceability
			K_s	K_d	Positive Wind Pressure	Negative Wind Pressure		Any direction wind pressure
400	400	1.0	0.377	0.281	9.000	-9.000	± 9.000	300
	600	1.5	0.628	0.566	9.000	-9.000	± 9.000	300
	800	2.0	0.786	0.740	9.000	-9.000	± 7.768	300
	1000	2.5	0.881	0.841	9.000	-8.528	± 4.957	300
	1200	3.0	0.942	0.911	9.000	-7.979	± 3.851	300
600	600	1.0	0.377	0.281	9.000	-8.873	± 6.982	300
	900	1.5	0.628	0.566	6.485	-5.321	± 3.155	300
	1200	2.0	0.786	0.740	5.177	-4.248	± 2.302	300
	1500	2.5	0.881	0.841	4.619	-3.790	± 1.469	300
	1800	3.0	0.942	0.911	4.322	-73.546	± 1.141	300
900	900	1.0	0.377	0.281	4.806	-3.944	± 1.716	300
	1350	1.5	0.628	0.566	2.882	-2.365	± 0.935	300
	1800	2.0	0.786	0.740	2.301	-1.888	± 0.682	300
	2250	2.5	0.881	0.841	2.053	-1.685	± 0.435	300
	2700	3.0	0.942	0.911	1.921	-1.576	± 0.338	300
1200	1200	1.0	0.377	0.281	2.703	-2.218	± 0.543	300
	1800	1.5	0.628	0.566	1.621	-1.330	± 0.362	300
	2400	2.0	0.786	0.740	1.294	-1.062	± 0.271	300
	3000	2.5	0.881	0.841	1.155	-0.948	± 0.184	300
	3600	3.0	0.942	0.911	1.080	-0.887	± 0.143	300
1500	1500	1.0	0.377	0.281	1.730	-1.420	± 0.222	300
	2250	1.5	0.628	0.566	1.038	-0.851	± 0.148	300
	3000	2.0	0.786	0.740	0.828	-0.680	± 0.111	300
	3750	2.5	0.881	0.841	0.739	-0.606	± 0.089	300
	4000	2.7	0.904	0.866	0.721	-0.591	± 0.083	300

See further note regards stiffeners on the next page.

7.5 Span Table Assumptions

The following assumptions regarding the ULTRACORE IQ product were made in relation to the analysis of the wall cladding system outlines in the span tables on the previous pages and should be taken into consideration when making structural engineering decisions:

- The aluminium sheets that make up the ULTRACORE IQ panel are of alloy/temper 3003-H24. This is equivalent to the AS/NZS 1664.1-1997 specified alloy/temper 3003-H14 for sheet & plate 0.2-25mm thickness.
- The stiffeners are a 38 x 19 x 3.0 RHS 6063-T5 aluminium section with the 38mm wide surface fixed to the back of the ULTRACORE IQ panel.
- The ULTRAZED z-angles that form part of the cassette fixing arrangement are structurally adequate for the ULTRACORE IQ panel span and fixing requirements outlined in this report (The ULTRAZED z-angle component is outside the scope of this report).
- The span and fixing of the supporting frame (studs and STUDTEK top-hats etc) are designed in accordance with the relevant Australian Standard such as AS/NZS 4600-2005 for each individual site-specific building with respect to the applied wind loading from AS1170.2-2011 (The STUDTEK top-hats and supporting structure components are outside the scope of this report).
- The support framing (including studs and STUDTEK top-hats etc) have a stiffness greater than that required to achieve a serviceability criterion of span/250.
- The ULTRACORE IQ panels are always supported along all four sides with screw/rivet fixings.
- The central profiled aluminium sheet of the panel does not contribute to the bending strength.

7.6 General Installation Guidelines:

- All sheets should be installed in the same direction as marked on the protective film to prevent possible finish variation.
- As minor colour variation can occur between production lots, it is recommended to place total requirements for a project in one order to ensure colour consistency.
- Where aluminium materials come into contact with dissimilar metals, a proper insulator, protective coating or caulking tape should be applied to insulate between dissimilar materials in order to avoid bimetallic corrosion and/or electrolytic action.
- The cassette fixed panel joints should not be caulked before the protective film is removed.
- The panel should be mechanically supported around penetrations and the face side should be sealed with a suitable sealant as required for weatherproofing.

7.7 Recommended Panel Sizes:

Panel sizes should be limited as required for any given application, considering the minimum & maximum temperatures the panel will be exposed to, the colour of the panel and the façade orientation to ensure the panels thermal movement will not exceed the systems capabilities and to ensure ongoing durability and waterproofing.

Special consideration should be given to the following.

- Overall panel sizes to ensure thermal movement will not exceed joint sealant capabilities
- Distance to joints either side of corner and parapet panels to avoid stress on the corner

8.1 Protective Film:

- Make sure no damage will occur to the panel prior to the removal of the protective film.
- Remove the protective film within 45 days of installation to avoid glue residue on panel surface due to weathering.
- Do not apply PVC tapes, polyurethane sealant or silicone sealant onto ULTRACORE IQ protective film. The plasticiser contained in these materials can penetrate the protective film and cause a gloss change in the coating.
- Do not apply spray paint or permanent marker to the film as the colour may penetrate the film and affect the surface coating of the panel.

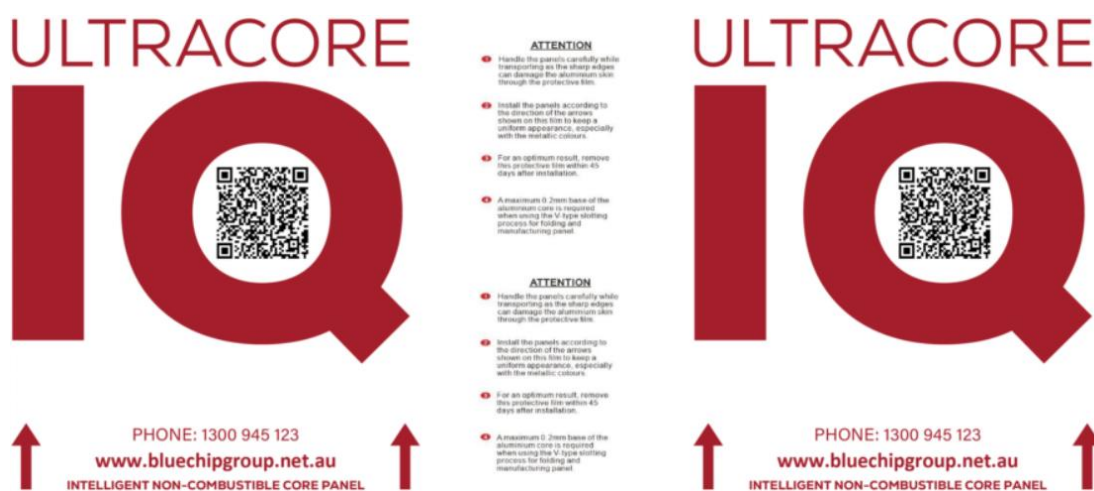

8.2 Storage & Handling:

- Considerable care should be taken in the handling of ULTRACORE IQ as the panels are sensitive to impact from small hard objects which can dent the aluminium cover sheet
- A minimum of two people should be used when moving and stacking sheets to avoid surface damage. Sliding panels should be avoided unless they are back-to-back.
- Pallets of ULTRACORE IQ should be stored horizontally in a cool and dry area where temperature is stable with adequate support to prevent sagging.
- Stacked pallets should be identically sized and not more than three (3) pallets high.

8.3 Cleaning & Maintenance:

- The cladding shall be cleaned and maintained in accordance with AAMA 609 & 610-09 as required to avoid any accumulation of surface contaminants and to maintain the desired performance and appearance.