

ULTRAWOOD Non-combustible Timber Cladding

UW-GR-CSF Concealed Screw Fix

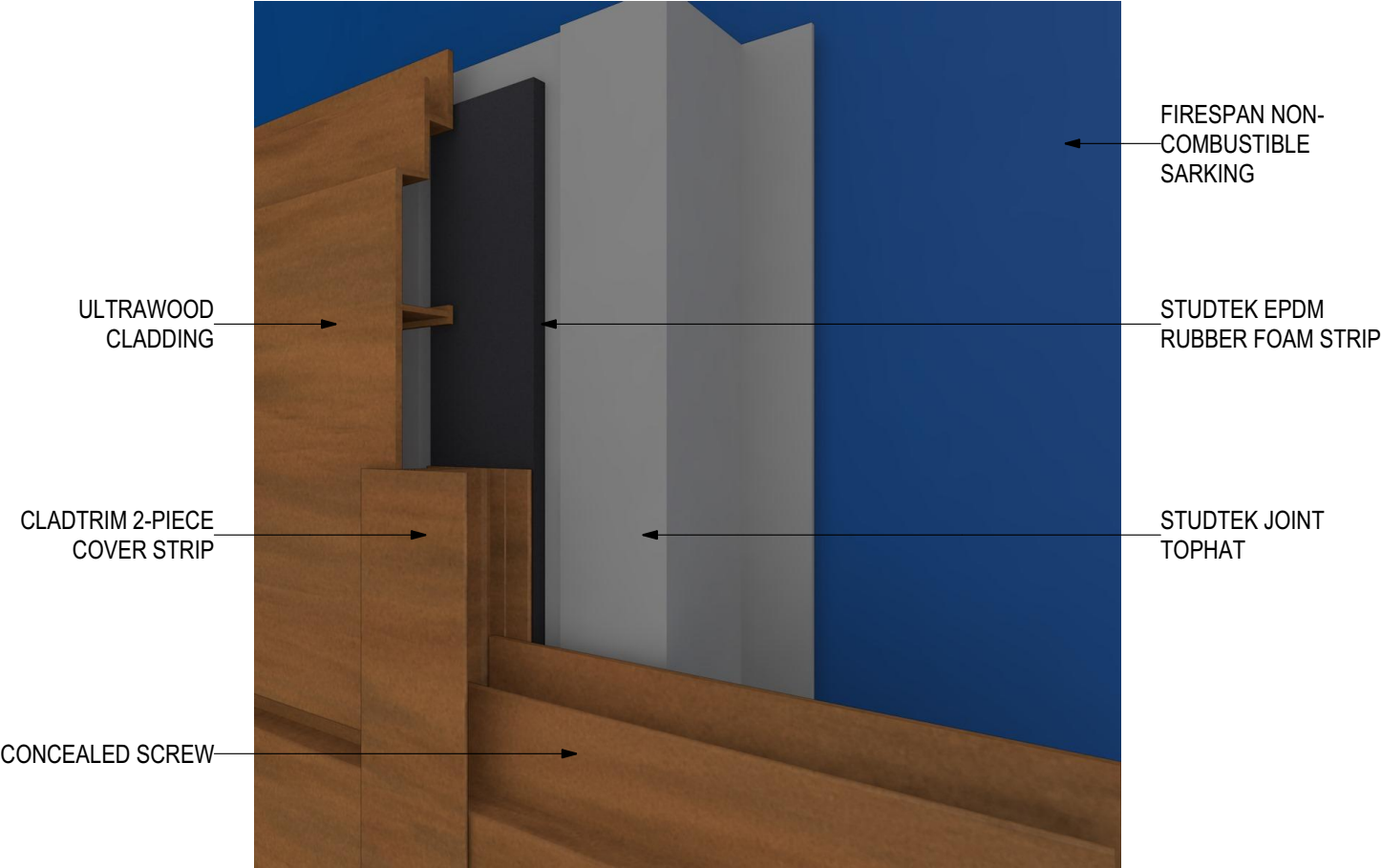

INSTALLATION DETAILS

Disclaimer: These details are general design details for use as a guide. Any use is at their own discretion and risk.

ULTRAWOOD Non-combustible Timber Cladding

UW-GR-CSF Concealed Screw Fix

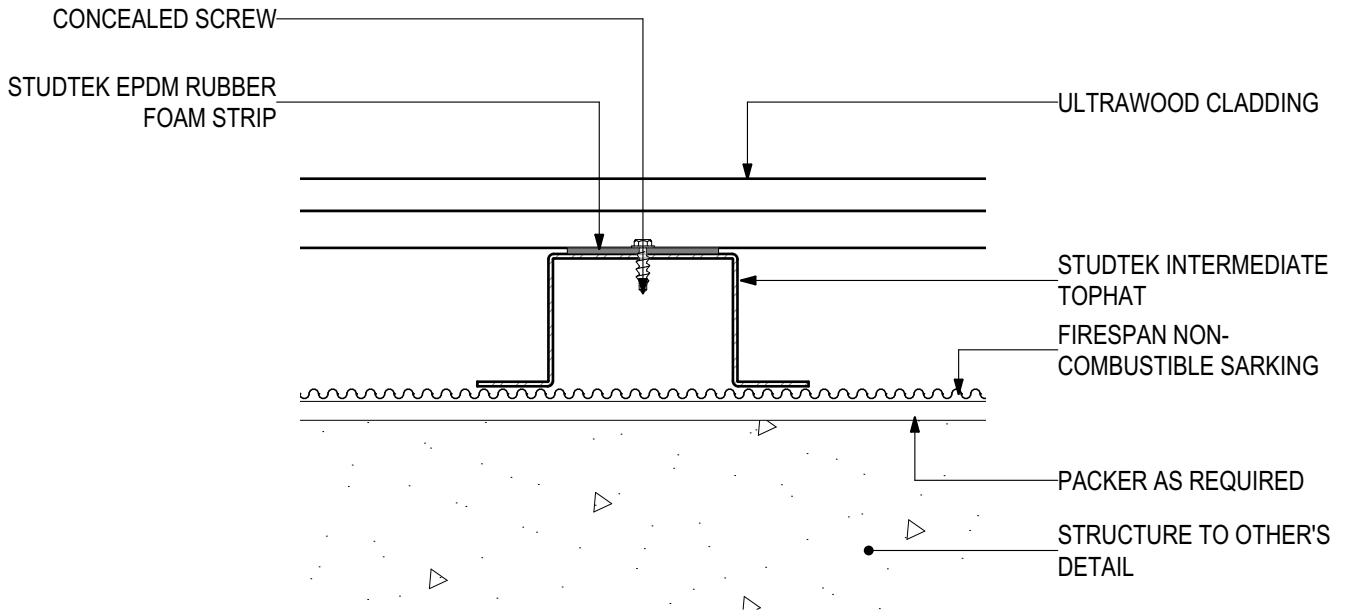

HORIZONTAL PANEL ARRANGEMENT

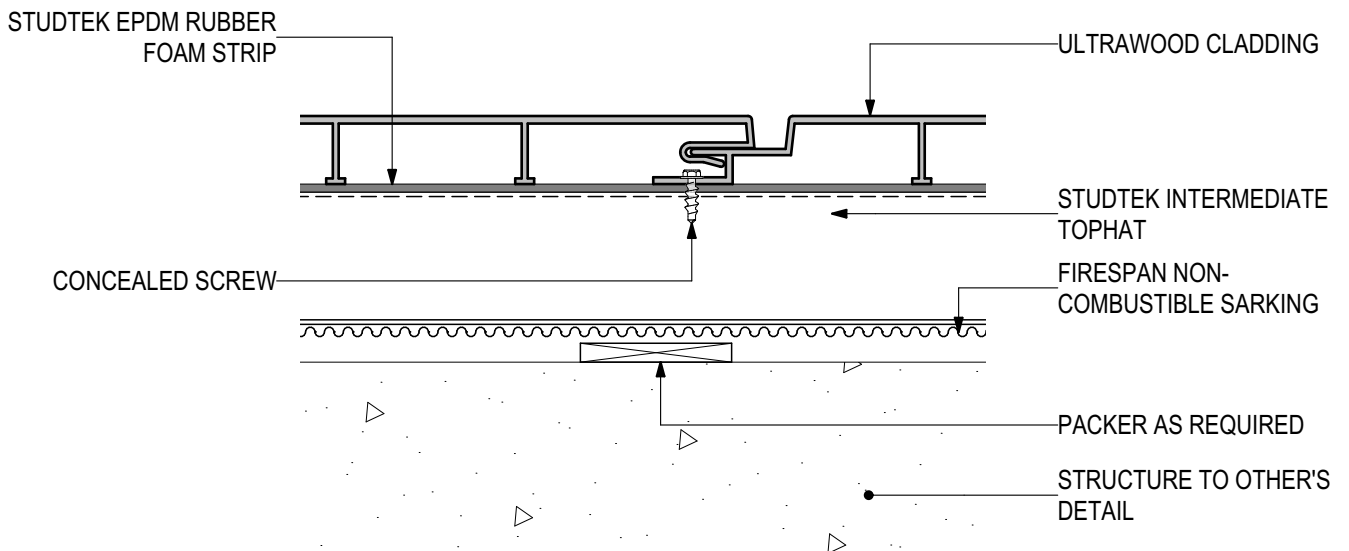

VERTICAL PANEL ARRANGEMENT

D.01 - TYPICAL FIXING DETAILS

SCALE 1:2

Disclaimer: These details are general design details for use as a guide. Any use is at their own discretion and risk.

ULTRAWOOD Non-combustible Timber Cladding

UW-GR-CSF Concealed Screw Fix

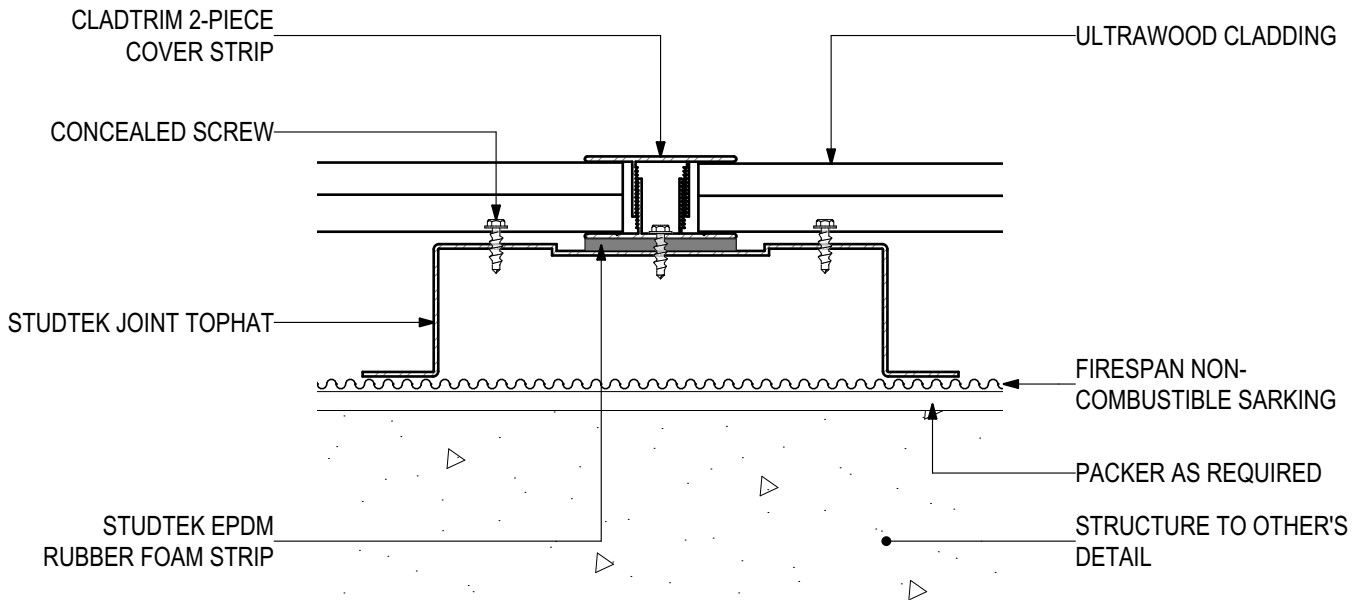

HORIZONTAL CLADDING JOINT

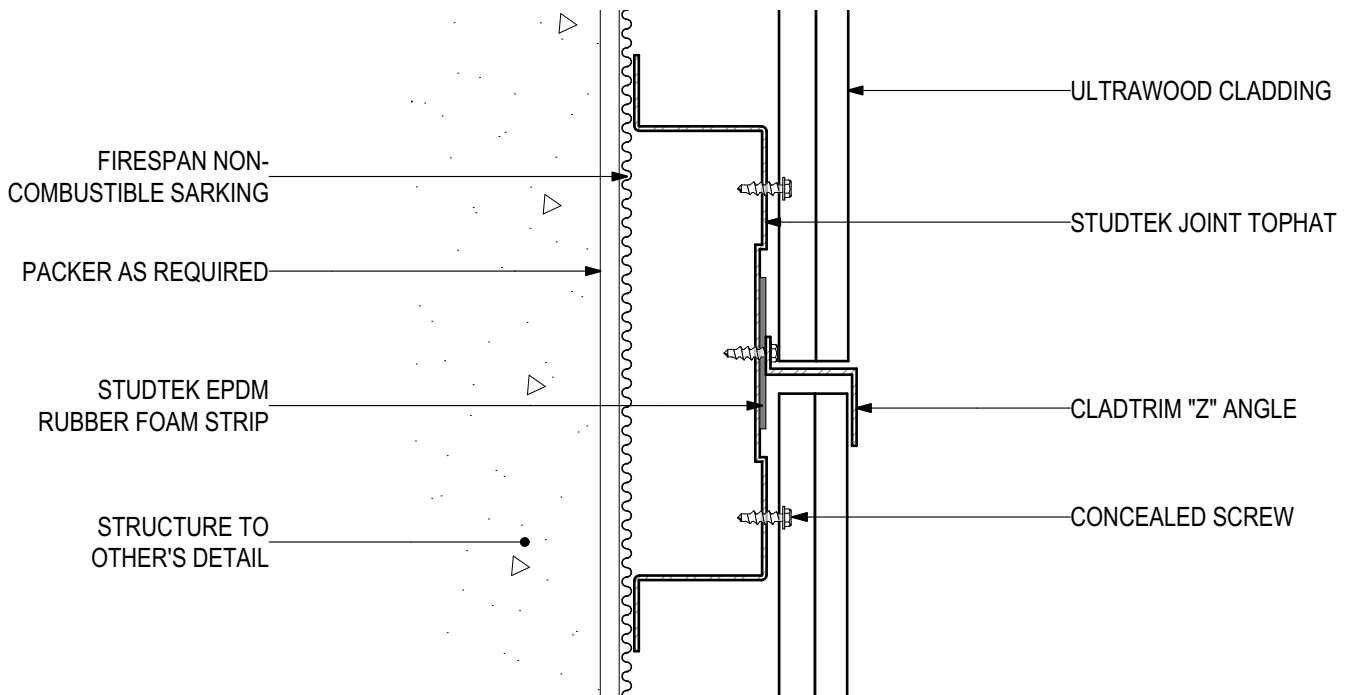

VERTICAL CLADDING JOINT

D.02 - JOINT DETAILS

SCALE 1:2

Disclaimer: These details are general design details for use as a guide. Any use is at their own discretion and risk.

ULTRAWOOD Non-combustible Timber Cladding UW-GR-CSF Concealed Screw Fix

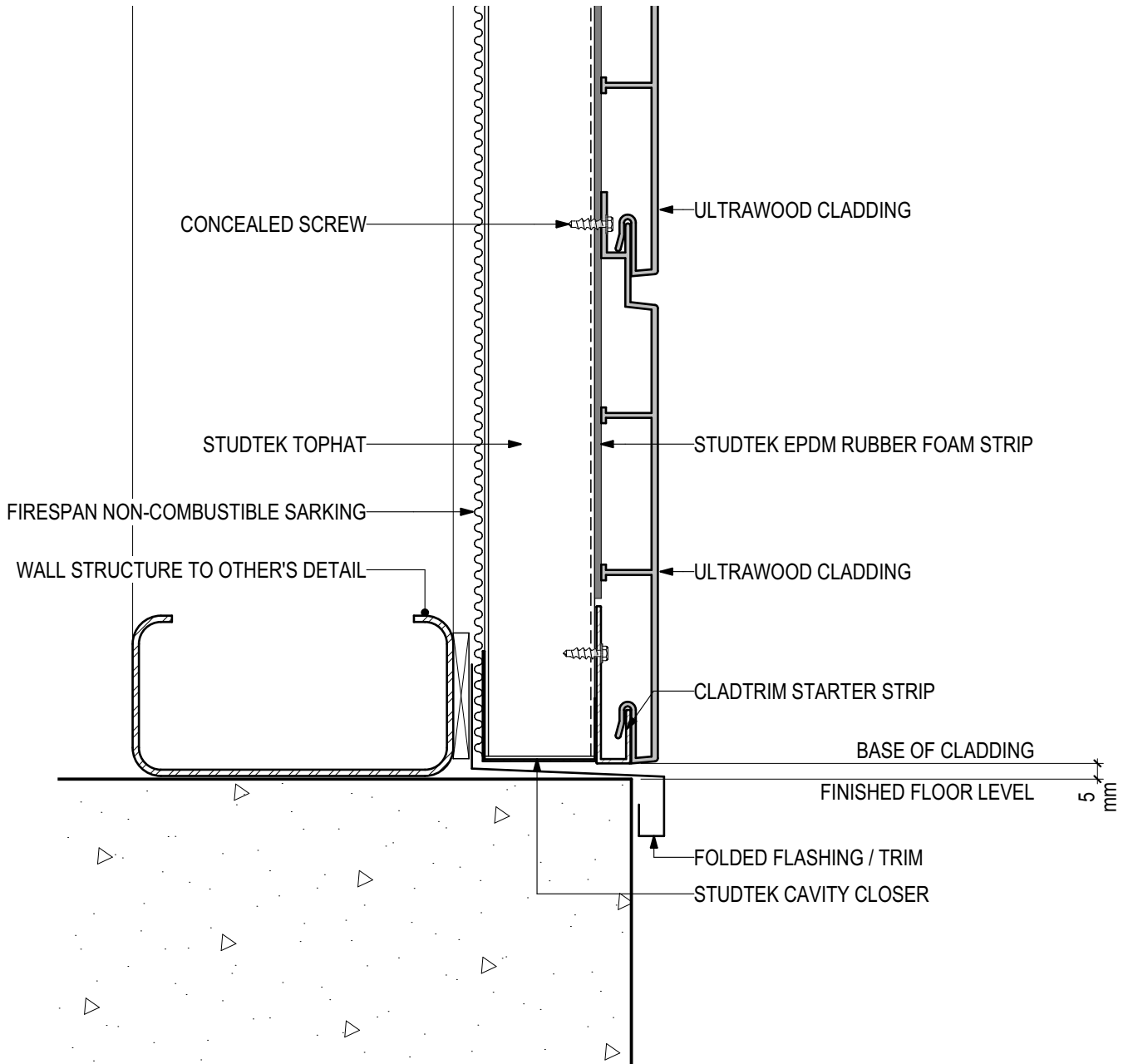

D.03 - BASE DETAIL

SCALE 1:2

Disclaimer: These details are general design details for use as a guide. Any use is at their own discretion and risk.

ULTRAWOOD Non-combustible Timber Cladding UW-GR-CSF Concealed Screw Fix

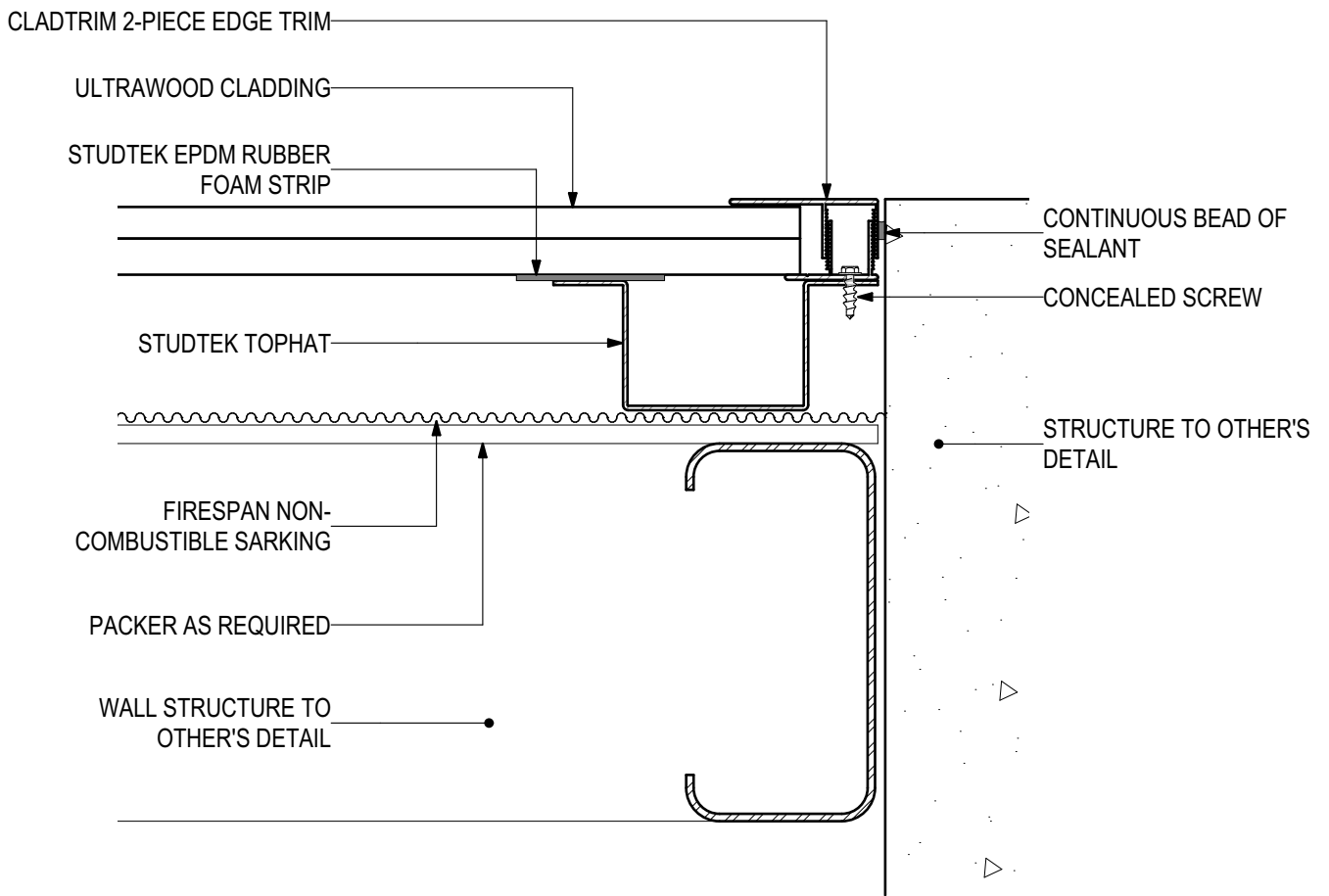

D.04 - WALL ABUTMENT

SCALE 1:2

Disclaimer: These details are general design details for use as a guide. Any use is at their own discretion and risk.

ULTRAWOOD Non-combustible Timber Cladding UW-GR-CSF Concealed Screw Fix

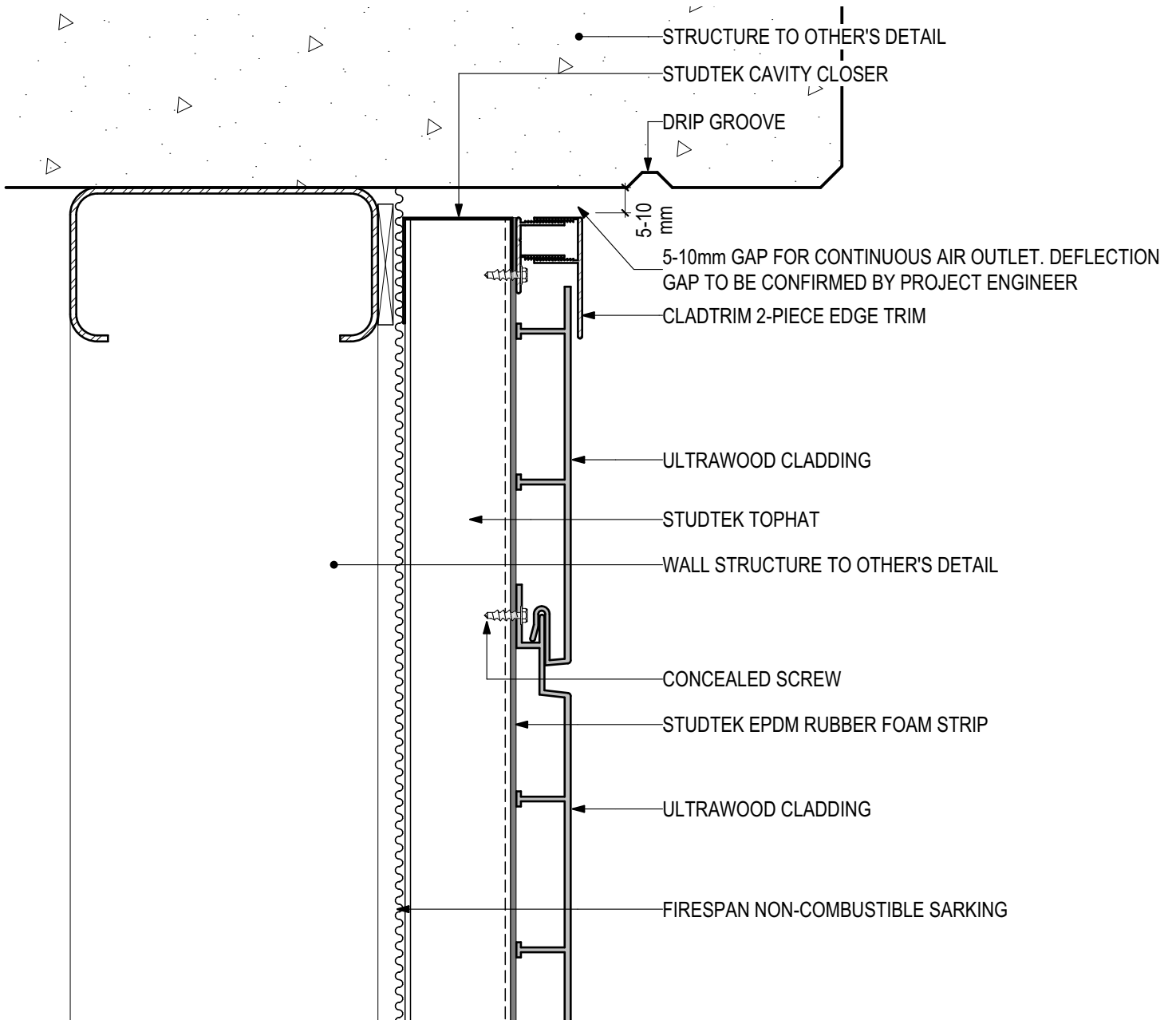

D.05 - HEAD AT SLAB

SCALE 1:2

Disclaimer: These details are general design details for use as a guide. Any use is at their own discretion and risk.

ULTRAWOOD Non-combustible Timber Cladding UW-GR-CSF Concealed Screw Fix

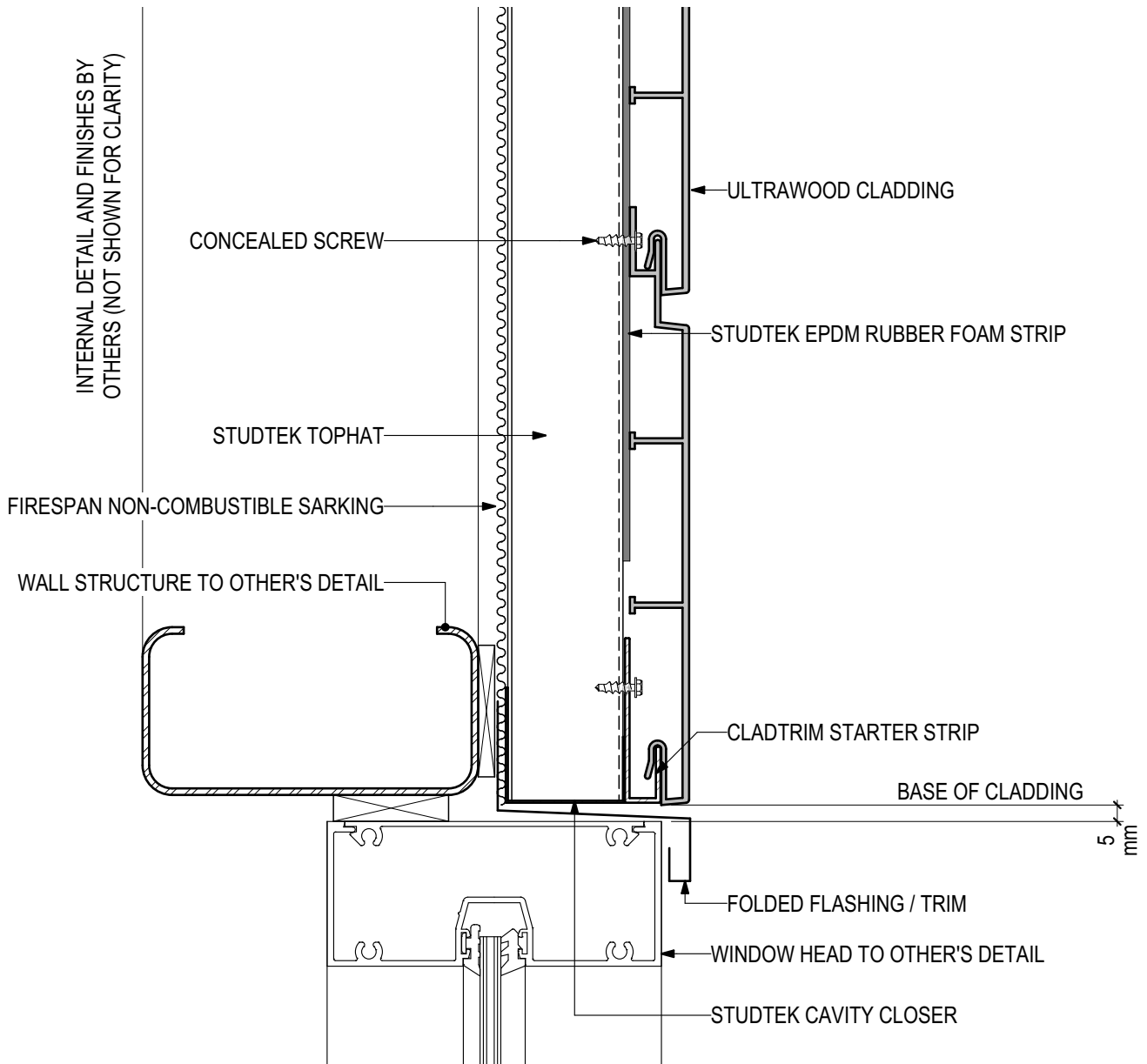

D.06 - WINDOW HEAD

SCALE 1:2

Disclaimer: These details are general design details for use as a guide. Any use is at their own discretion and risk.

ULTRAWOOD Non-combustible Timber Cladding UW-GR-CSF Concealed Screw Fix

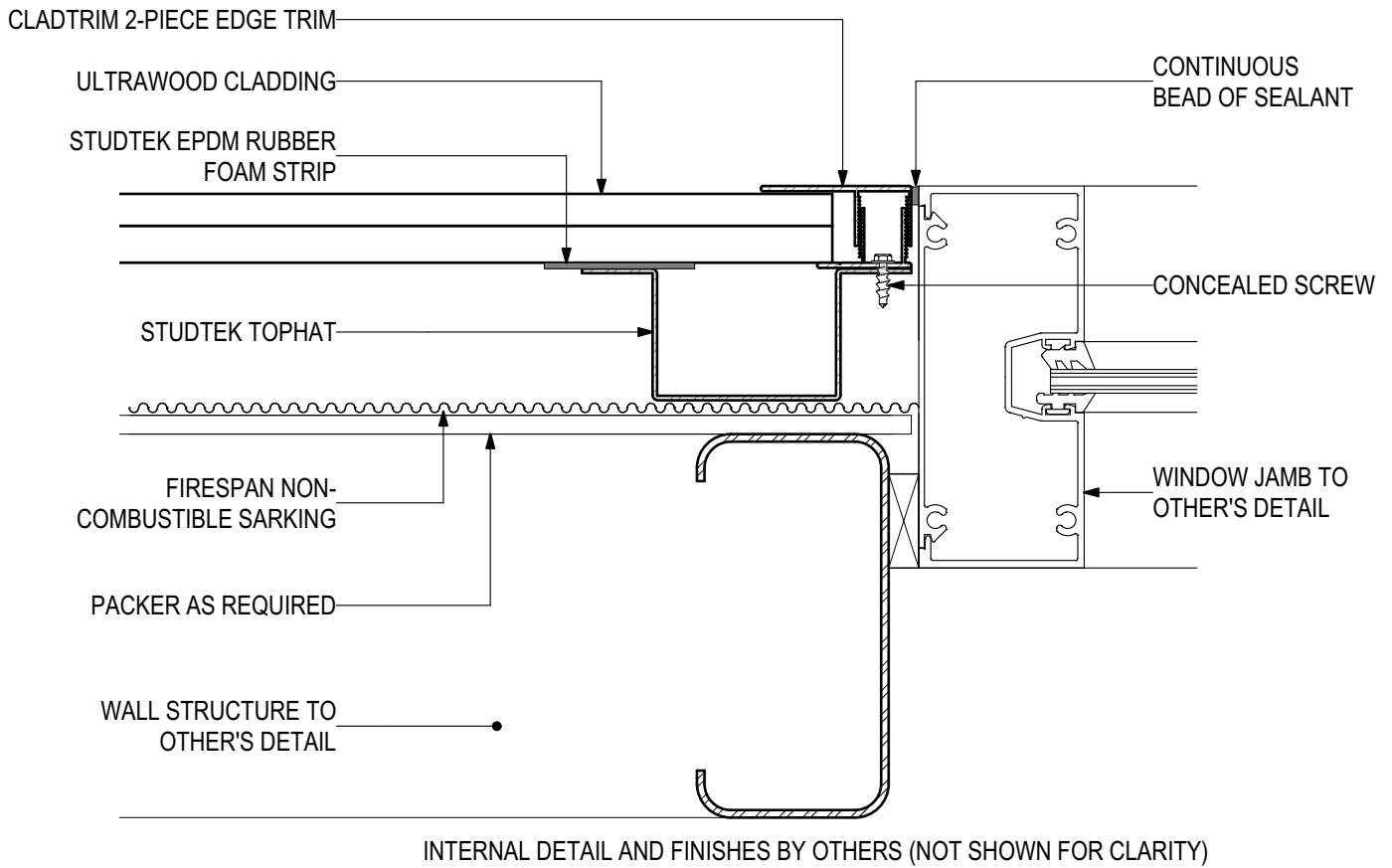

D.07 - WINDOW JAMB

SCALE 1:2

Disclaimer: These details are general design details for use as a guide. Any use is at their own discretion and risk.

ULTRAWOOD Non-combustible Timber Cladding

UW-GR-CSF Concealed Screw Fix

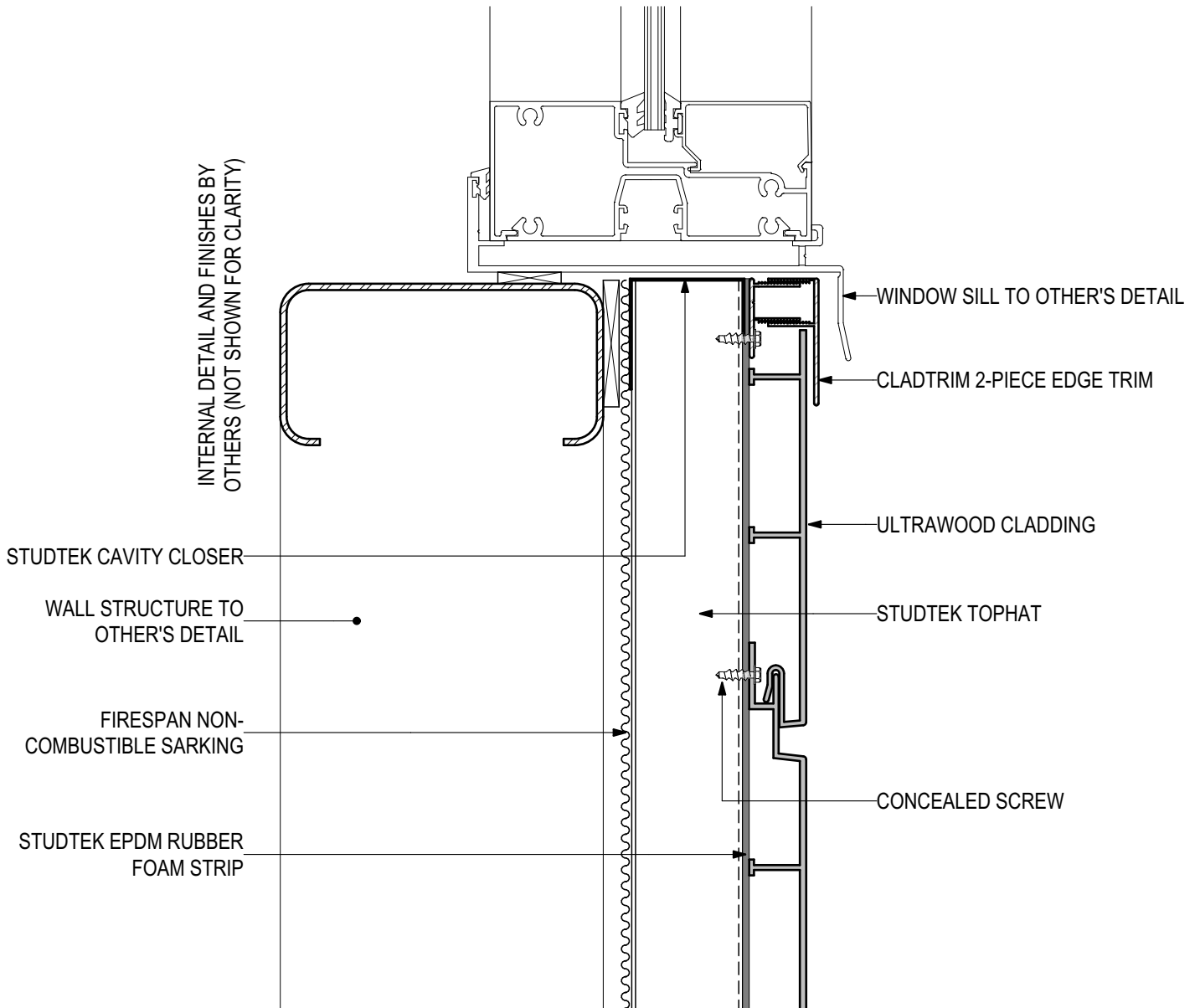

D.08 - WINDOW SILL

SCALE 1:2

Disclaimer: These details are general design details for use as a guide. Any use is at their own discretion and risk.

ULTRAWOOD Non-combustible Timber Cladding UW-GR-CSF Concealed Screw Fix

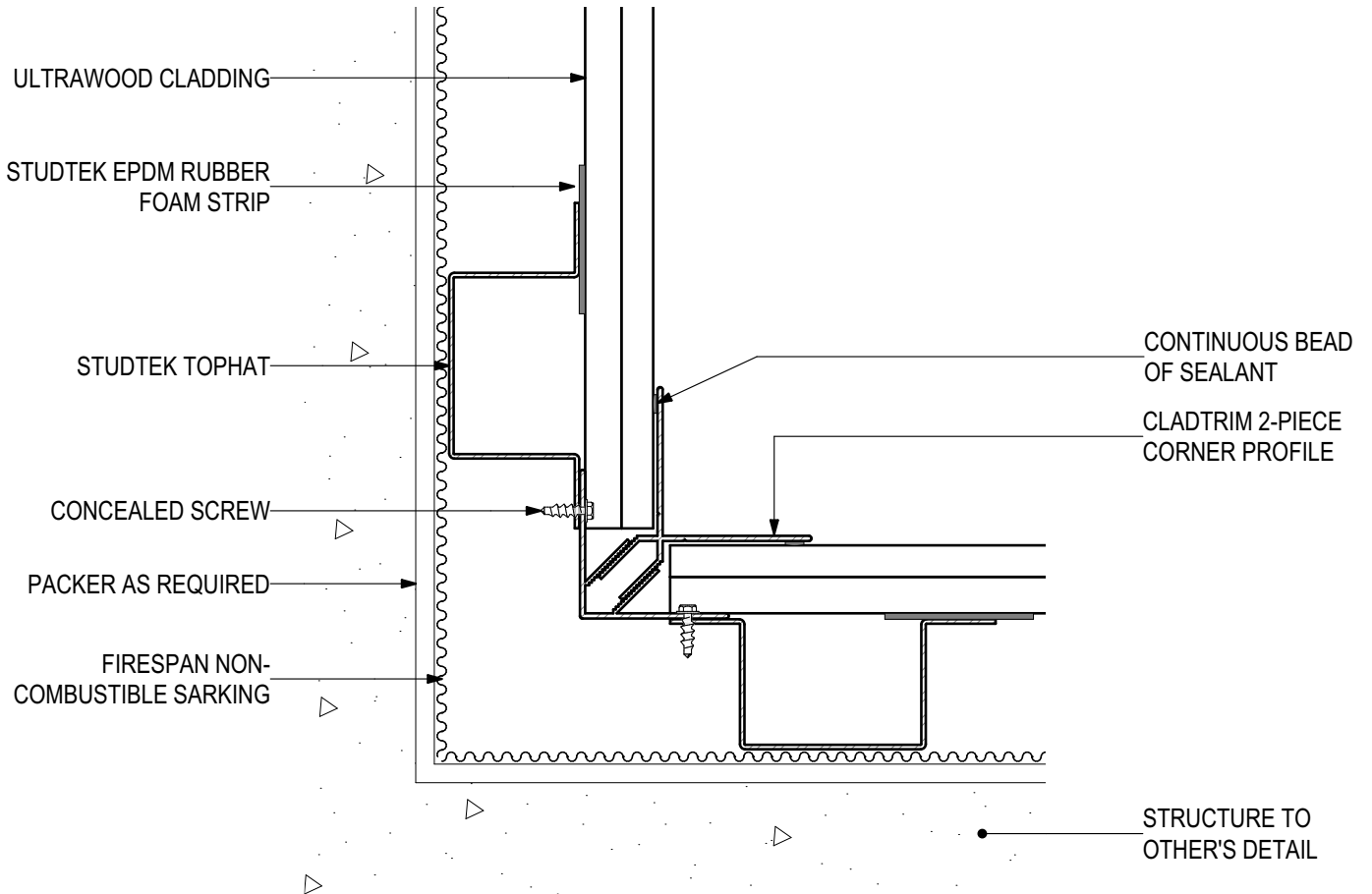

D.09 - INTERNAL CORNER

SCALE 1:2

Disclaimer: These details are general design details for use as a guide. Any use is at their own discretion and risk.

ULTRAWOOD Non-combustible Timber Cladding UW-GR-CSF Concealed Screw Fix

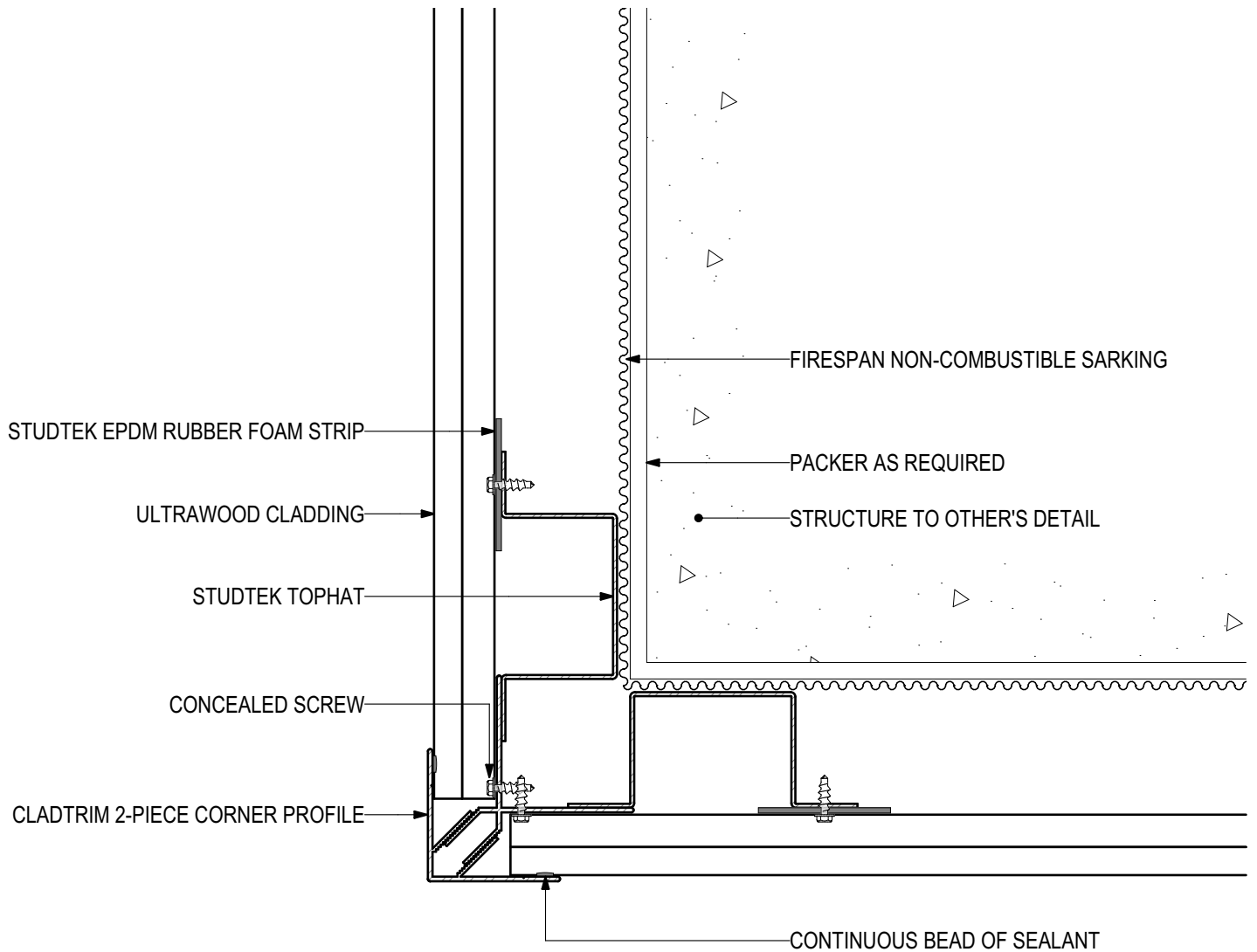

D.10 - EXTERNAL CORNER

SCALE 1:2

Disclaimer: These details are general design details for use as a guide. Any use is at their own discretion and risk.

ULTRAWOOD Non-combustible Timber Cladding UW-GR-CSF Concealed Screw Fix

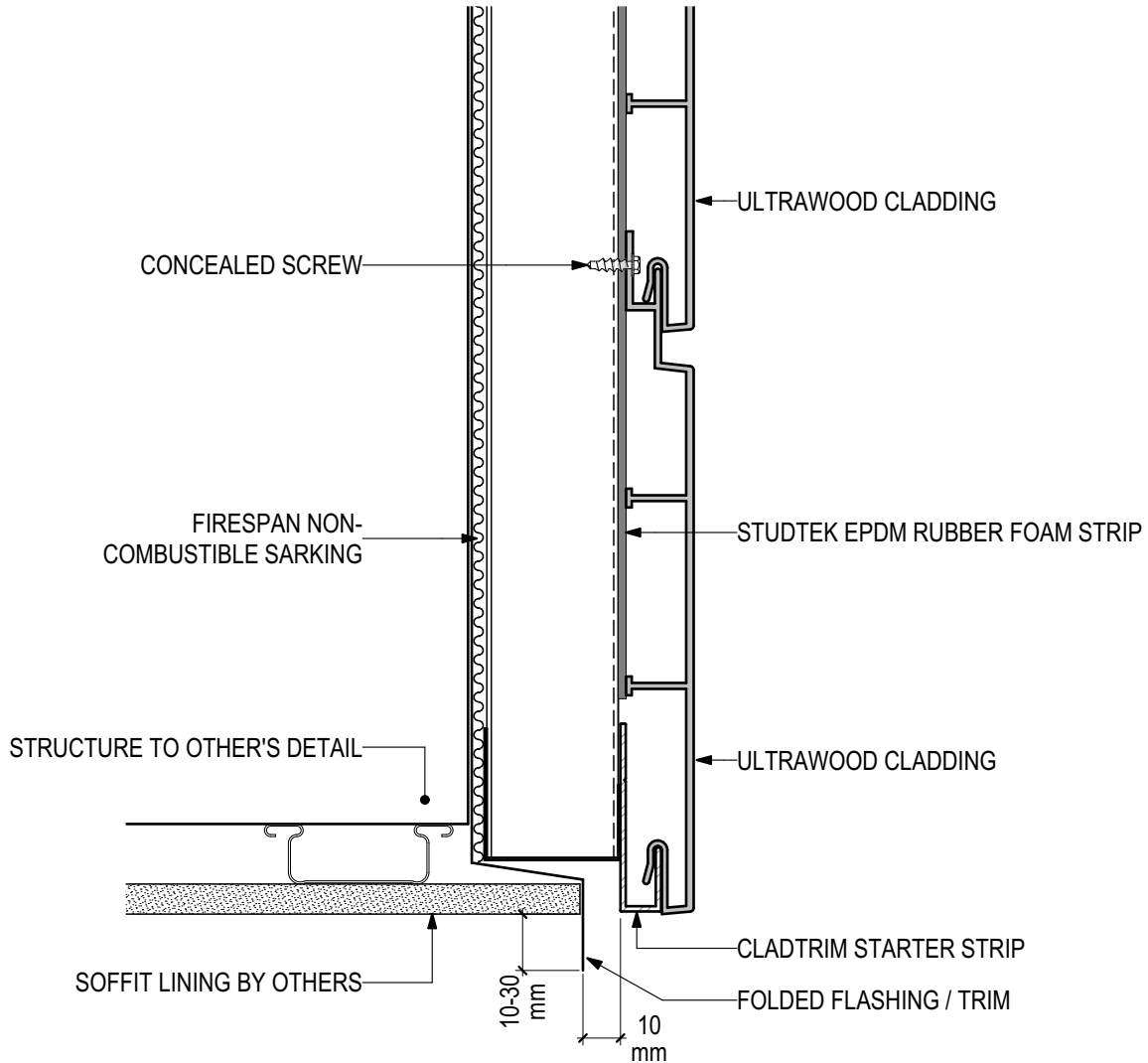

D.11 - EAVE JUNCTION

SCALE 1:2

Disclaimer: These details are general design details for use as a guide. Any use is at their own discretion and risk.

ULTRAWOOD Non-combustible Timber Cladding UW-GR-CSF Concealed Screw Fix

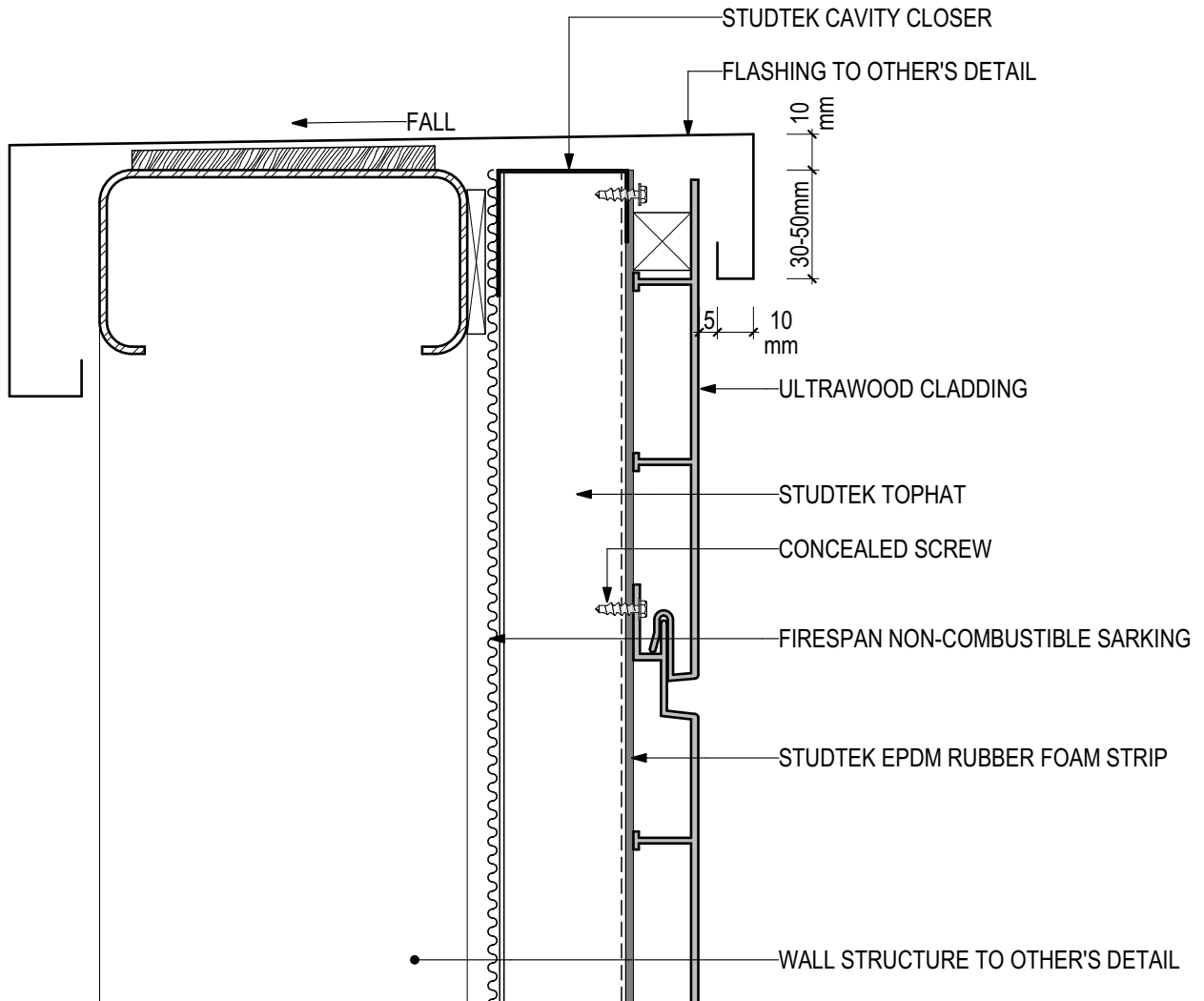

D.12 - PARAPET DETAIL

SCALE 1:2

Disclaimer: These details are general design details for use as a guide. Any use is at their own discretion and risk.

ULTRAWOOD Non-combustible Timber Cladding
UW-GR-CSF Concealed Screw Fix

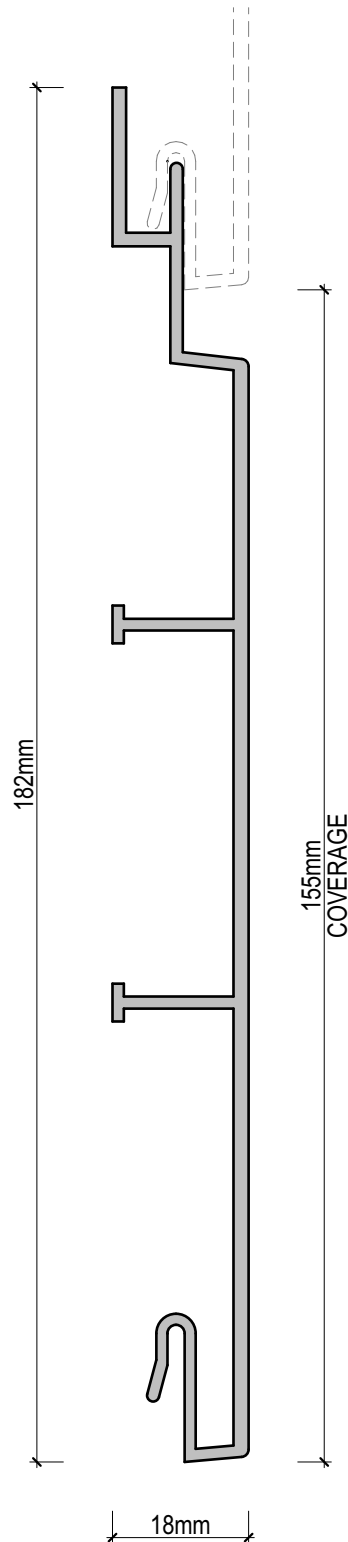

ULTRAWOOD PROFILE (UWG155)

SCALE 1:1

Disclaimer: These details are general design details for use as a guide.
Any use is at their own discretion and risk.