

ULTRAPEARL Pre-finished Fibre Cement Panel

UP-09-VSF Visible Screw Fix

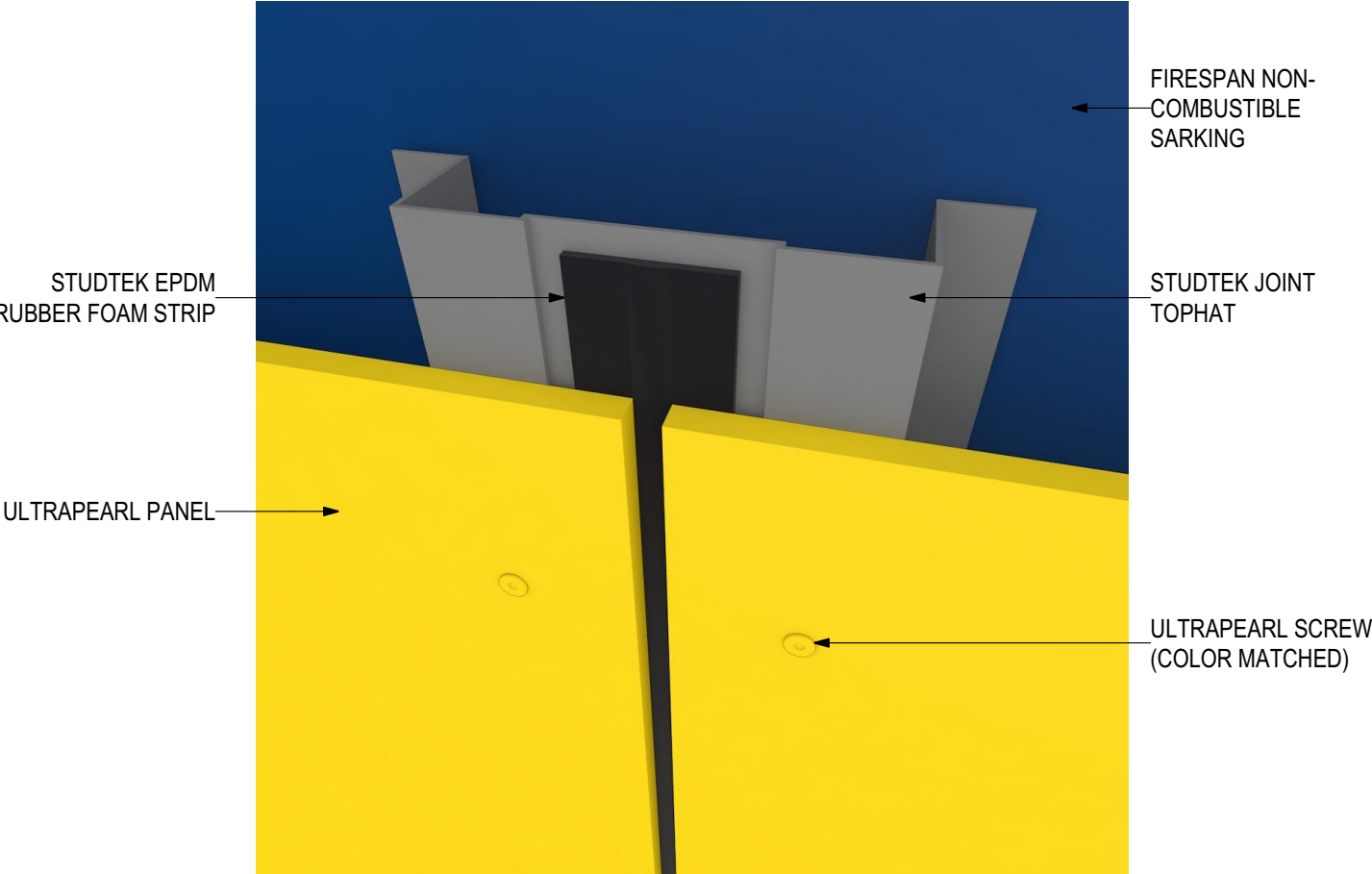

INSTALLATION DETAILS

Disclaimer: These details are general design details for use as a guide. Any use is at their own discretion and risk.

ULTRAPEARL Pre-finished Fibre Cement Panel UP-09-VSF Visible Screw Fix

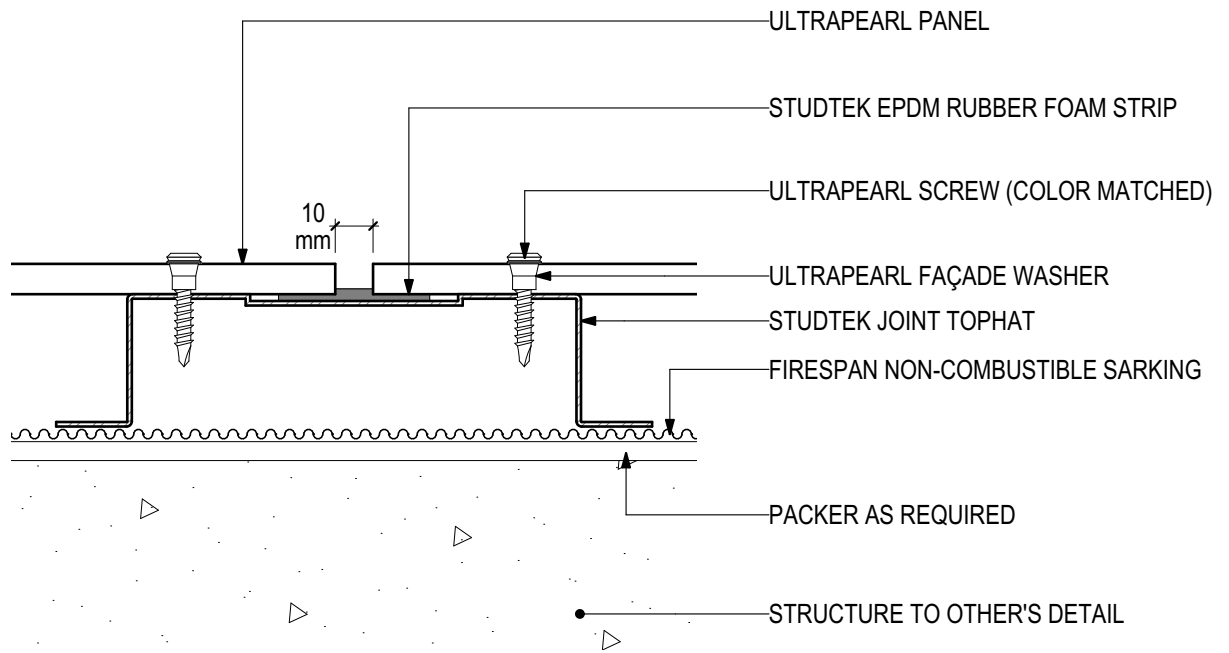

D.01 - TYPICAL FIXING DETAIL

SCALE 1:2

Disclaimer: These details are general design details for use as a guide. Any use is at their own discretion and risk.

ULTRAPEARL Pre-finished Fibre Cement Panel UP-09-VSF Visible Screw Fix

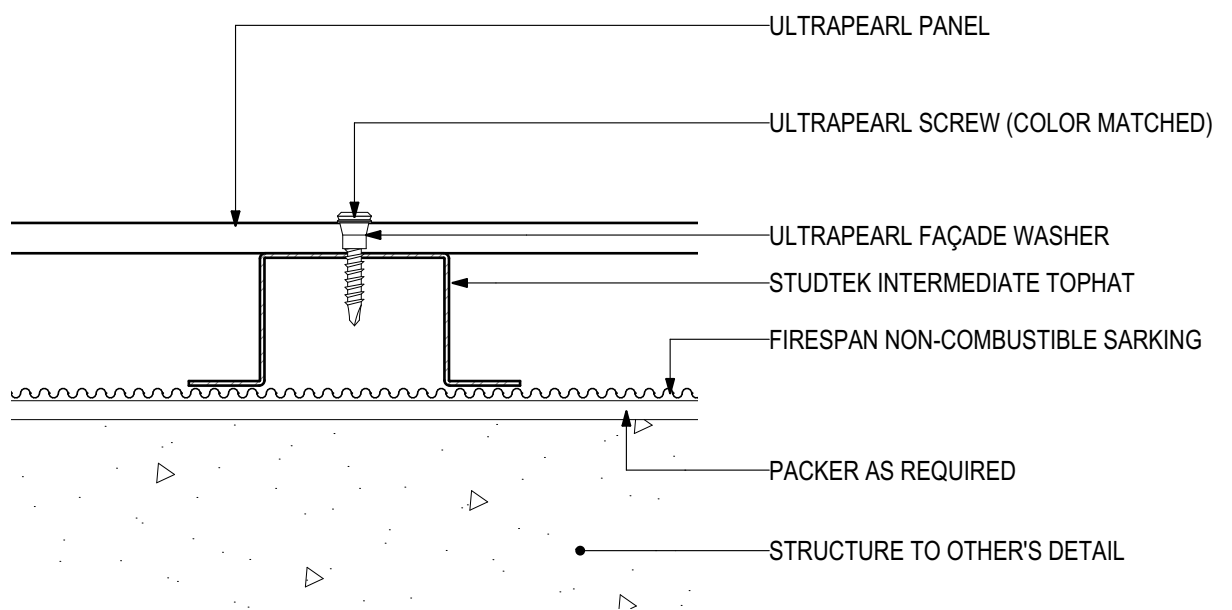

D.02 - INTERMEDIATE DETAIL

SCALE 1:2

Disclaimer: These details are general design details for use as a guide.
Any use is at their own discretion and risk.

ULTRAPEARL Pre-finished Fibre Cement Panel

UP-09-VSF Visible Screw Fix

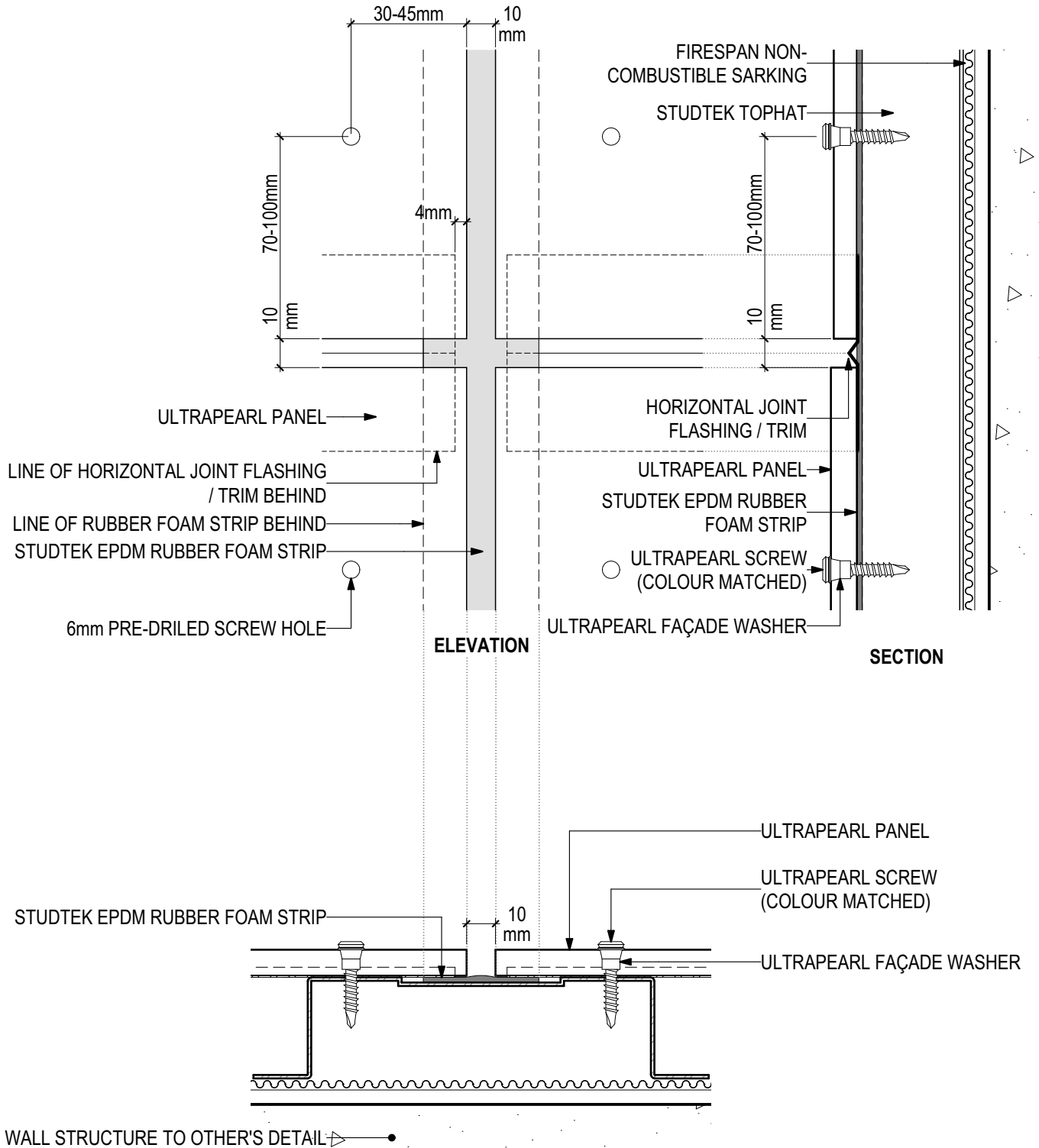

D.03 - EXPRESSED JOINT DETAIL

SCALE 1:2

Disclaimer: These details are general design details for use as a guide. Any use is at their own discretion and risk.

ULTRAPEARL Pre-finished Fibre Cement Panel UP-09-VSF Visible Screw Fix

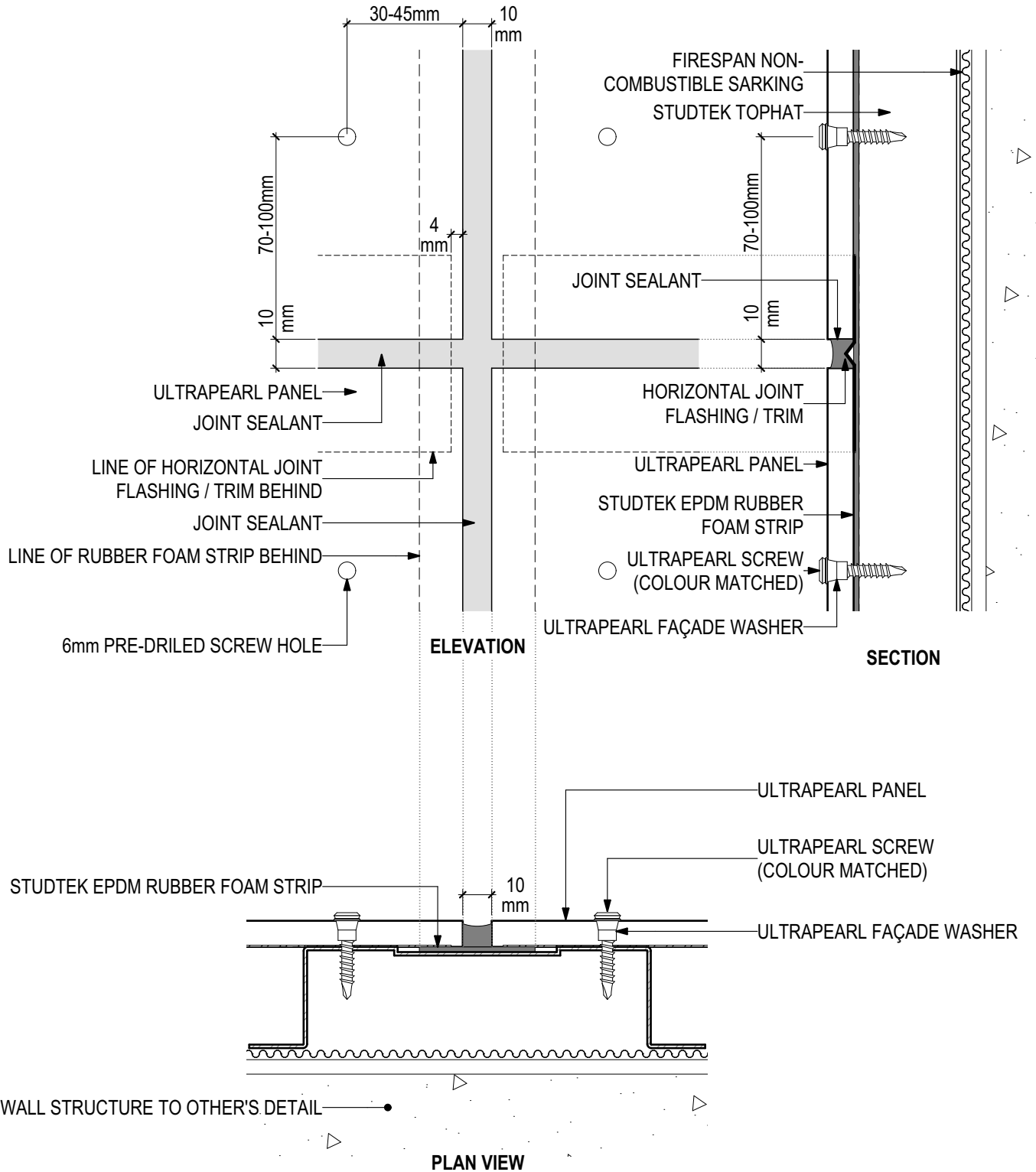

D.04 - SEALED JOINT DETAIL

SCALE 1:2

Disclaimer: These details are general design details for use as a guide. Any use is at their own discretion and risk.

ULTRAPEARL Pre-finished Fibre Cement Panel

UP-09-VSF Visible Screw Fix

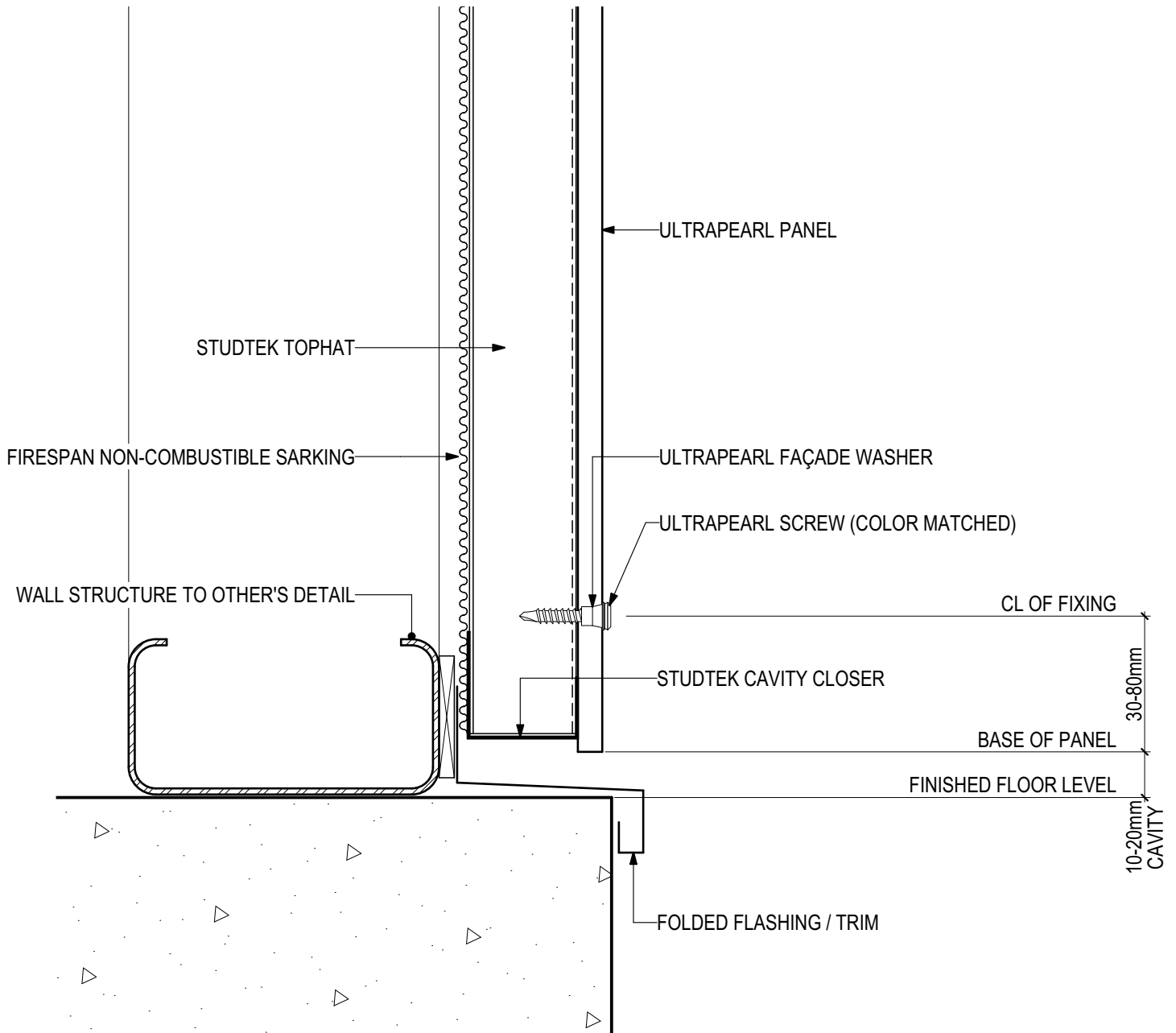

D.05 - BASE DETAIL

SCALE 1:2

Disclaimer: These details are general design details for use as a guide. Any use is at their own discretion and risk.

ULTRAPEARL Pre-finished Fibre Cement Panel UP-09-VSF Visible Screw Fix

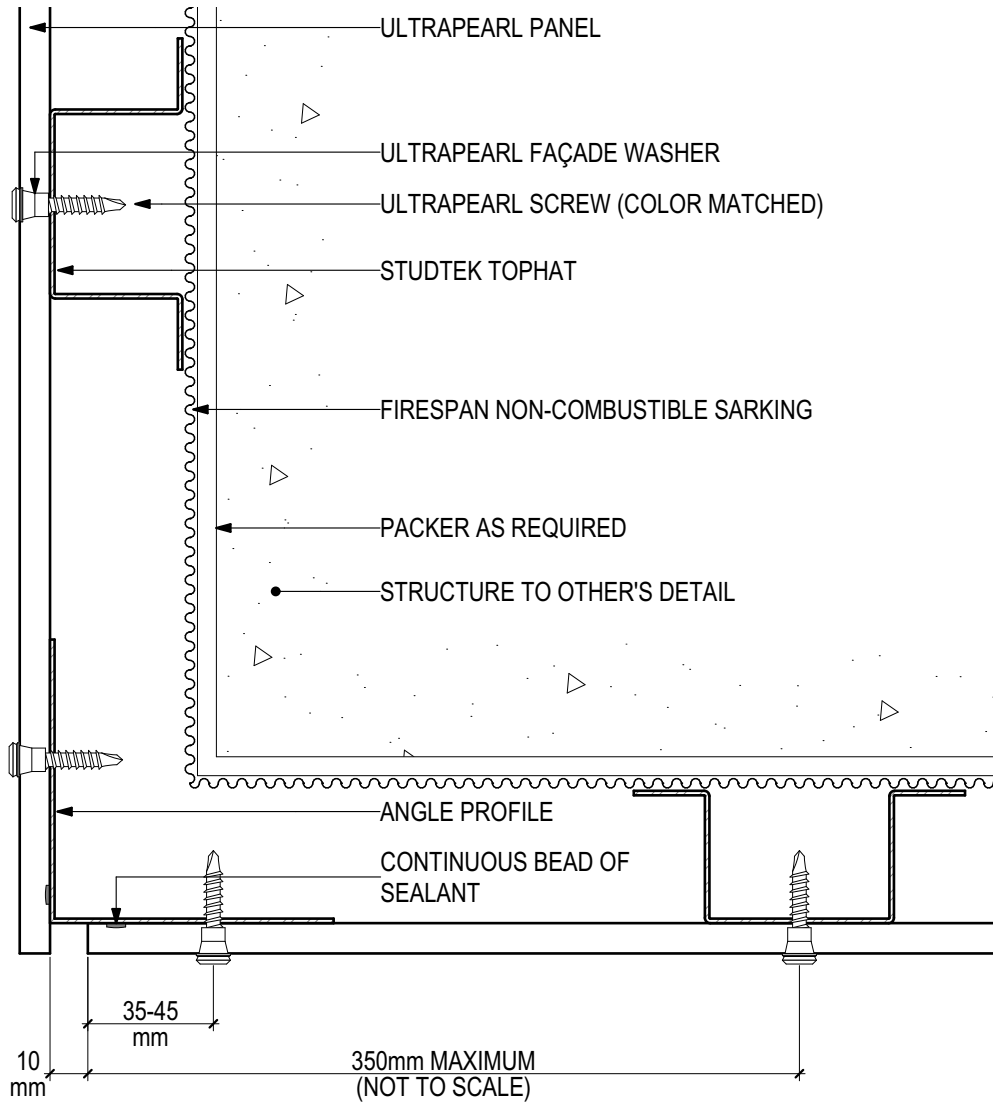

D.06 - EXTERNAL CORNER

SCALE 1:2

Disclaimer: These details are general design details for use as a guide. Any use is at their own discretion and risk.

ULTRAPEARL Pre-finished Fibre Cement Panel UP-09-VSF Visible Screw Fix

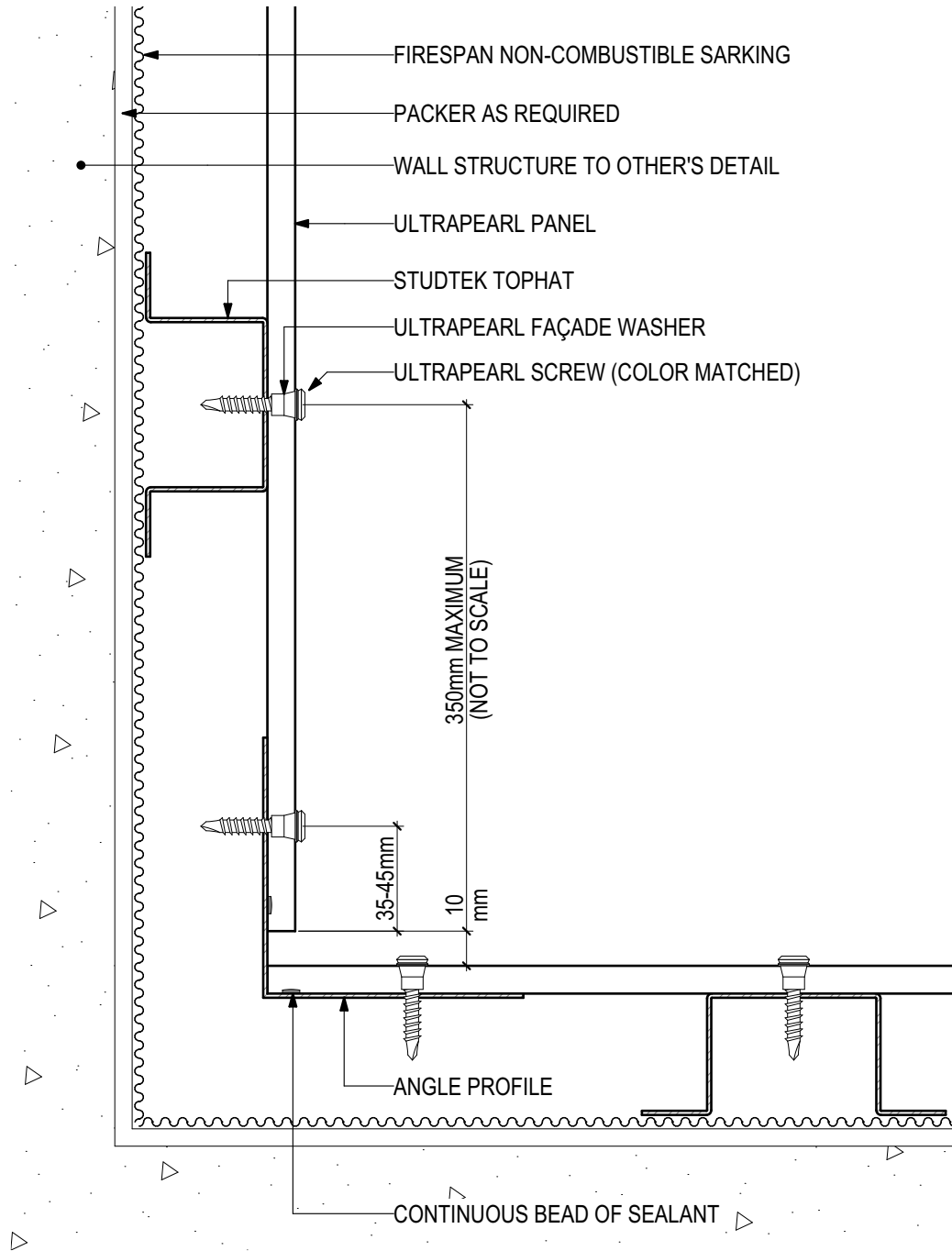

D.07 - INTERNAL CORNER

SCALE 1:2

Disclaimer: These details are general design details for use as a guide. Any use is at their own discretion and risk.

ULTRAPEARL Pre-finished Fibre Cement Panel UP-09-VSF Visible Screw Fix

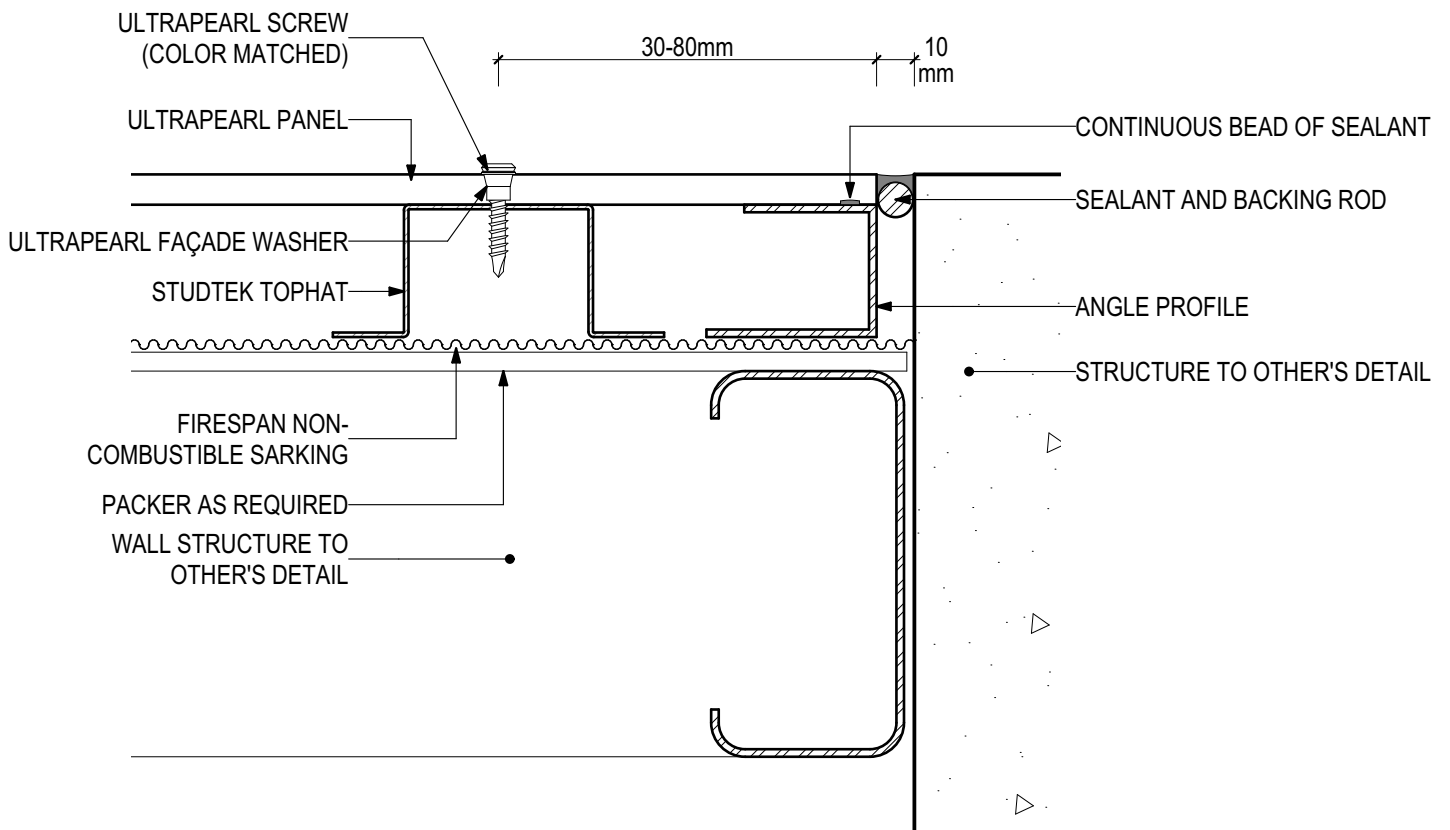

D.08 - WALL ABUTMENT

SCALE 1:2

Disclaimer: These details are general design details for use as a guide. Any use is at their own discretion and risk.

ULTRAPEARL Pre-finished Fibre Cement Panel UP-09-VSF Visible Screw Fix

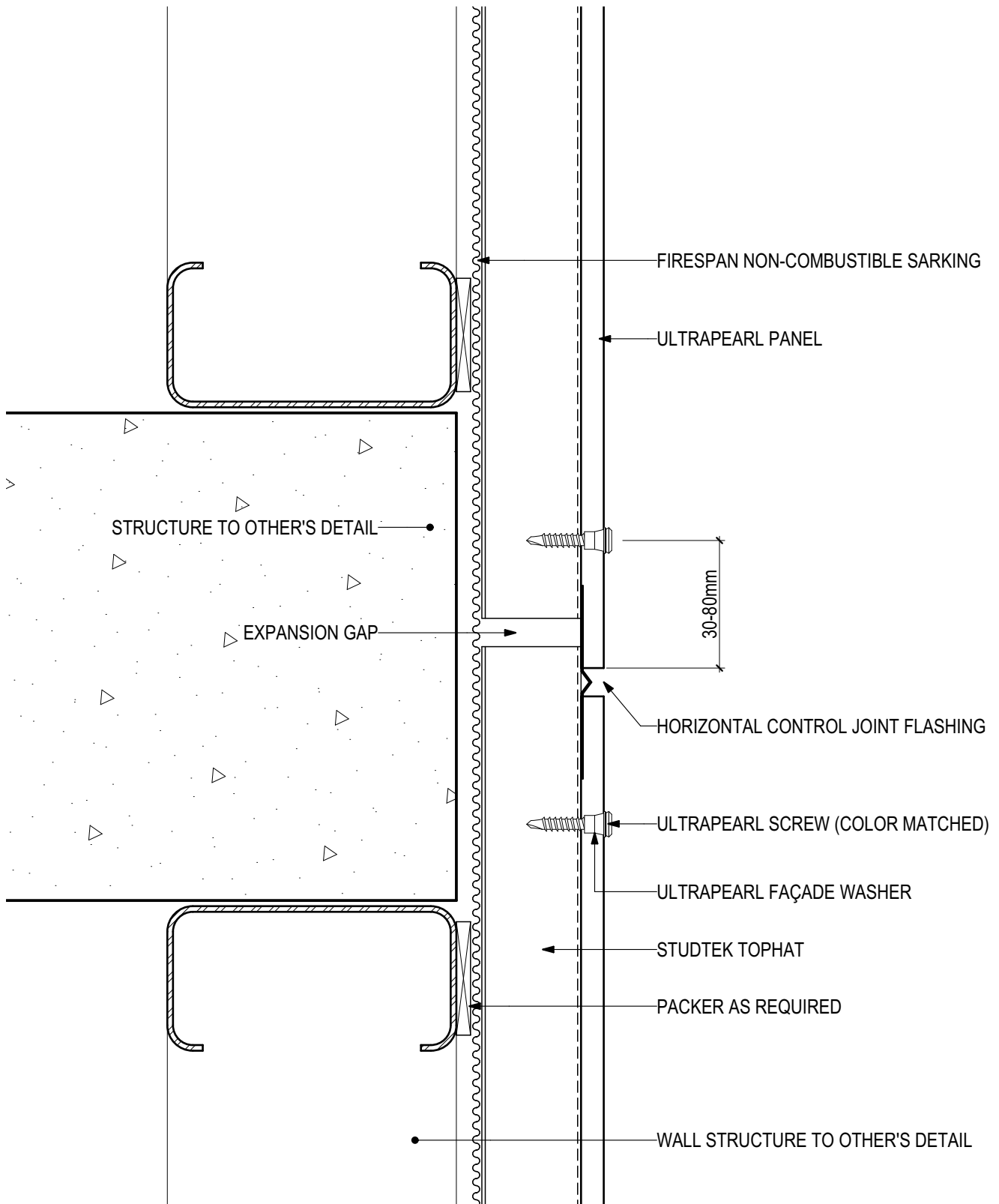

D.09 - HORIZONTAL CONTROL JOINT

SCALE 1:2

Disclaimer: These details are general design details for use as a guide. Any use is at their own discretion and risk.

ULTRAPEARL Pre-finished Fibre Cement Panel UP-09-VSF Visible Screw Fix

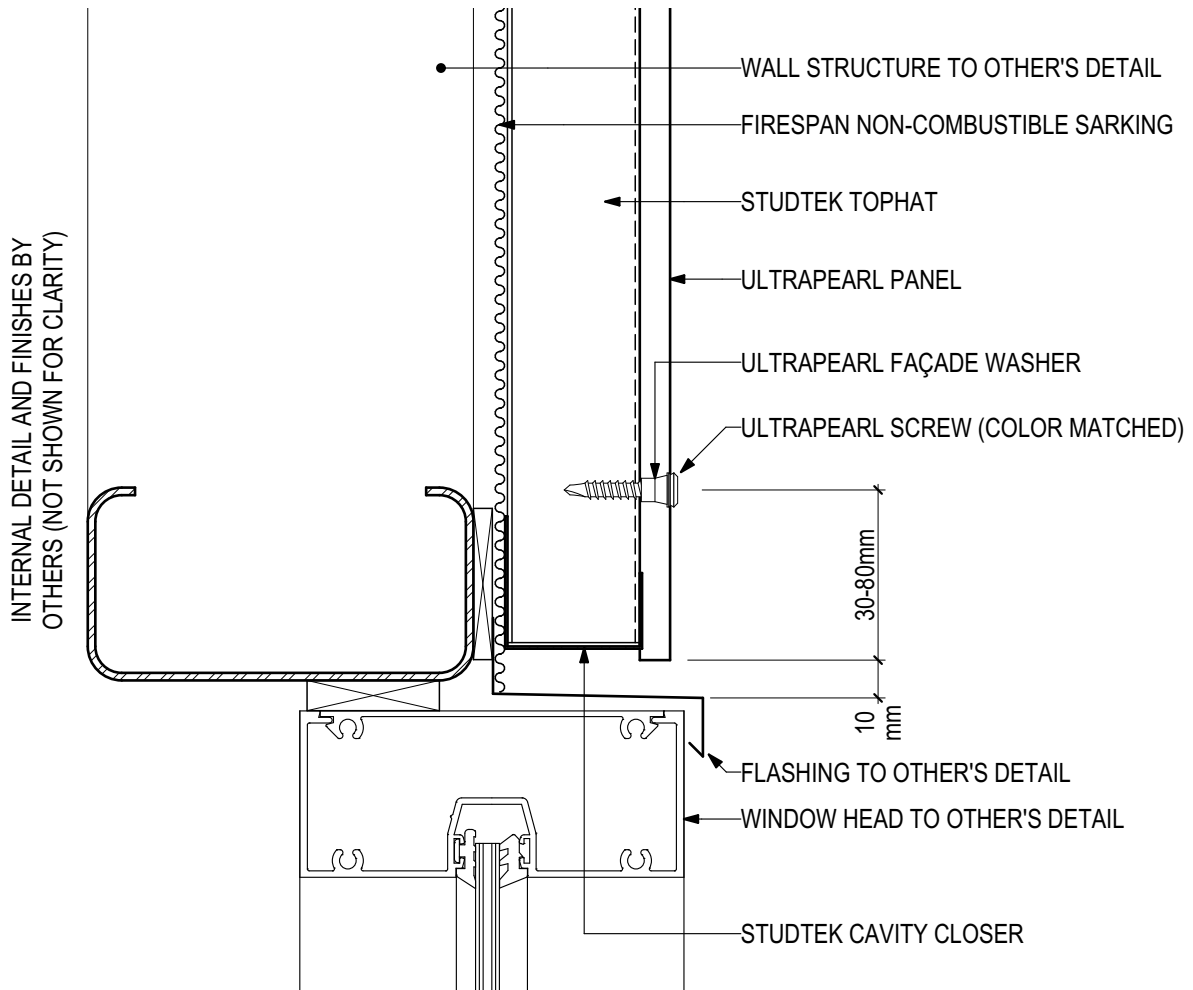

D.10 - WINDOW HEAD

SCALE 1:2

Disclaimer: These details are general design details for use as a guide. Any use is at their own discretion and risk.

ULTRAPEARL Pre-finished Fibre Cement Panel UP-09-VSF Visible Screw Fix

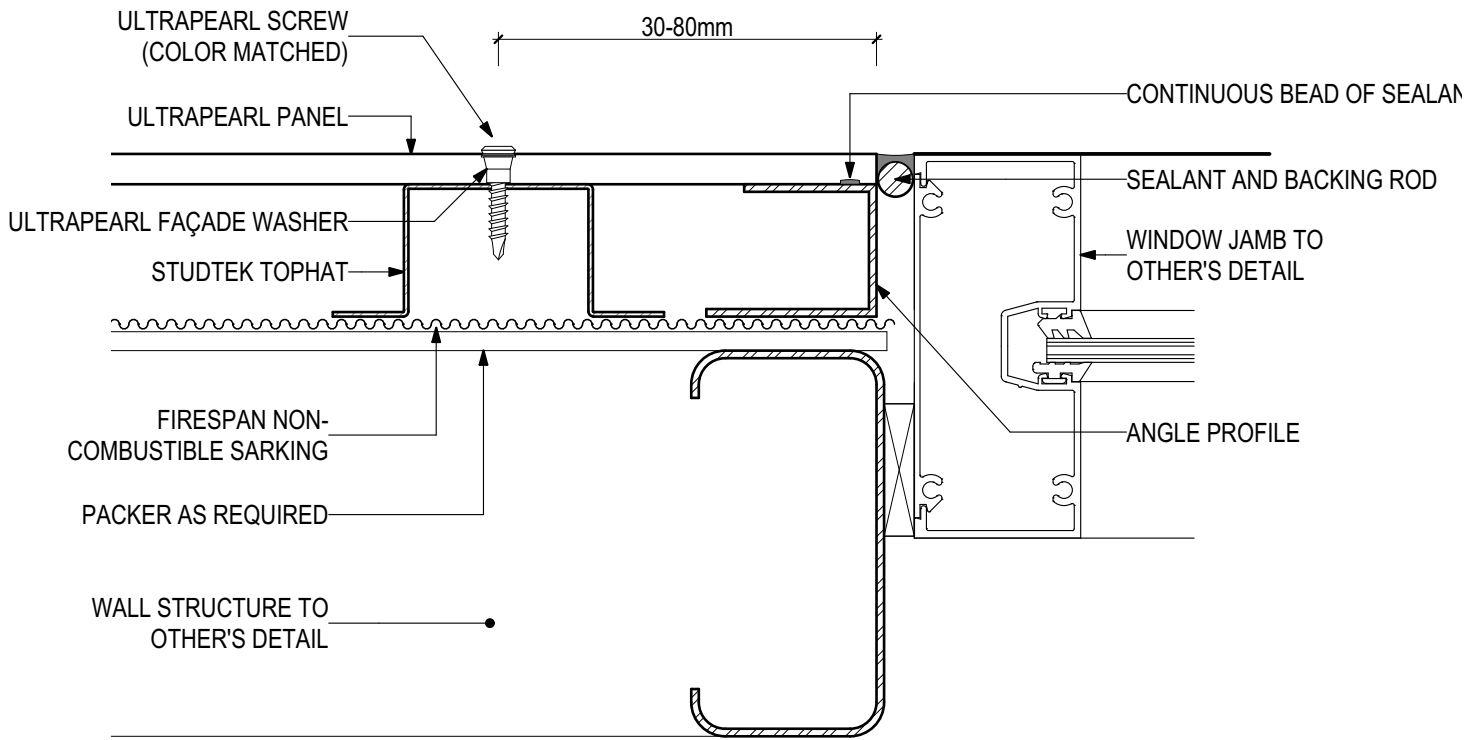

INTERNAL DETAIL AND FINISHES BY OTHERS (NOT SHOWN FOR CLARITY)

D.11 - WINDOW JAMB

SCALE 1:2

Disclaimer: These details are general design details for use as a guide. Any use is at their own discretion and risk.

ULTRAPEARL Pre-finished Fibre Cement Panel UP-09-VSF Visible Screw Fix

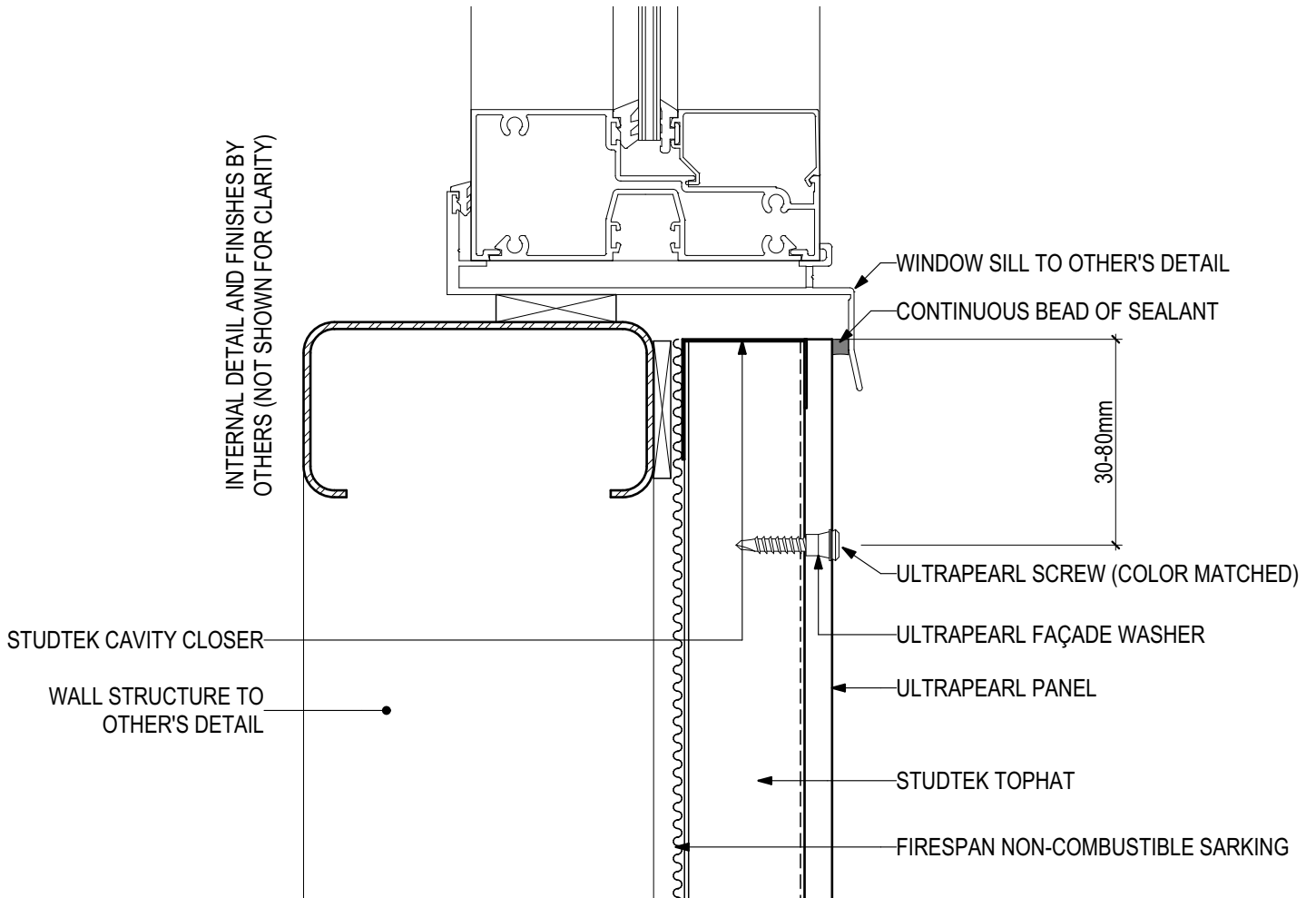

D.12 - WINDOW SILL

SCALE 1:2

Disclaimer: These details are general design details for use as a guide.
Any use is at their own discretion and risk.

ULTRAPEARL Pre-finished Fibre Cement Panel UP-09-VSF Visible Screw Fix

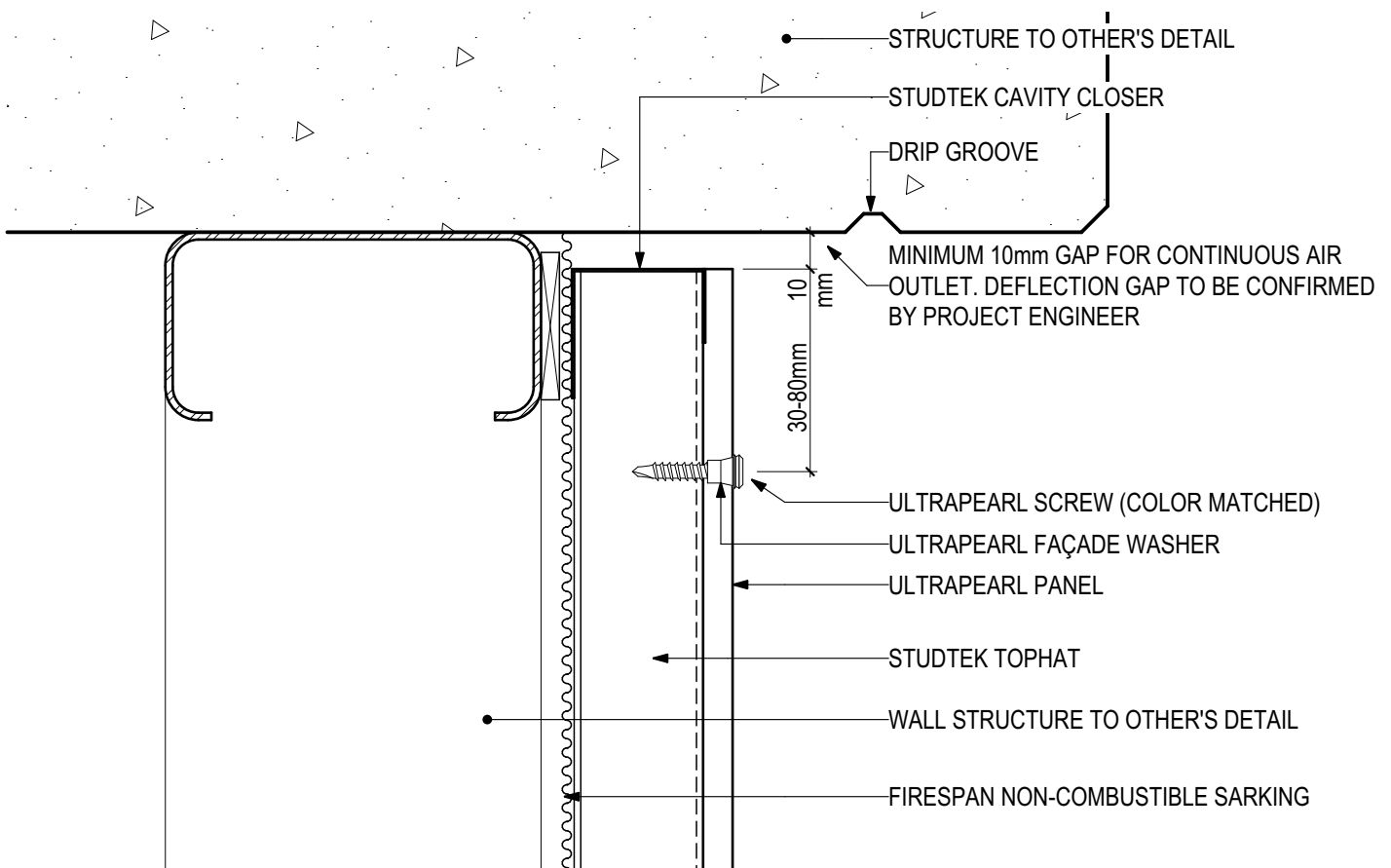

D.13 - HEAD AT SLAB JUNCTION

SCALE 1:2

Disclaimer: These details are general design details for use as a guide. Any use is at their own discretion and risk.

ULTRAPEARL Pre-finished Fibre Cement Panel UP-09-VSF Visible Screw Fix

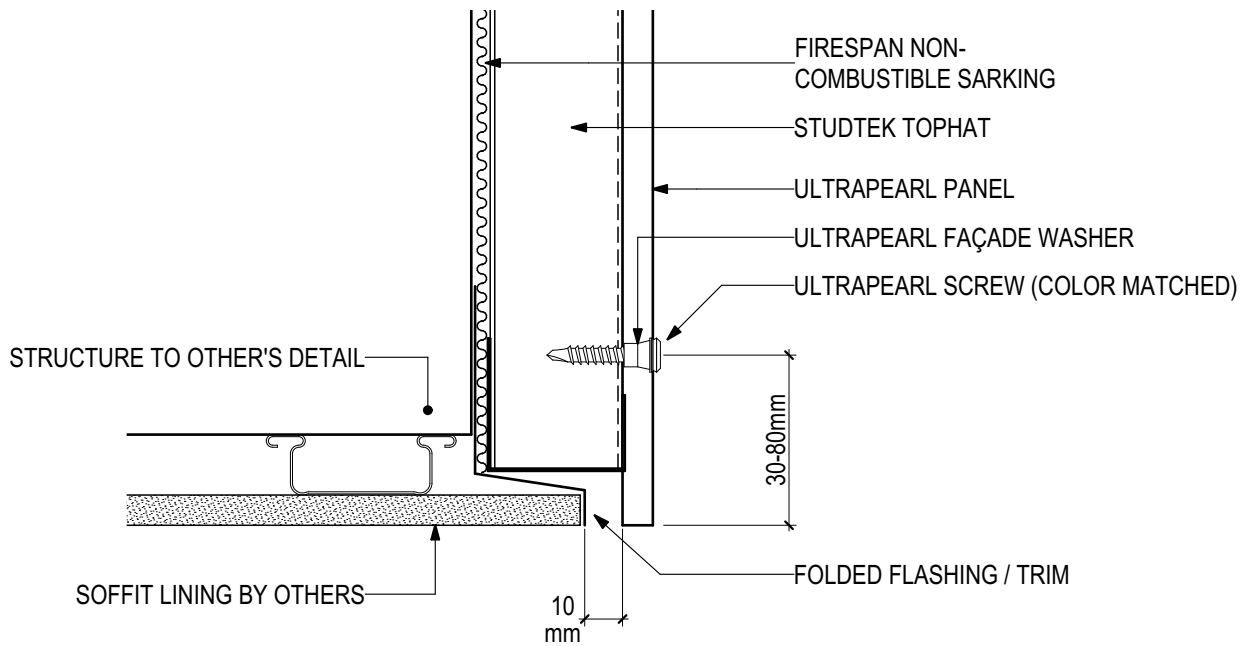

D.14 - SOFFIT JUNCTION

SCALE 1:2

Disclaimer: These details are general design details for use as a guide. Any use is at their own discretion and risk.

ULTRAPEARL Pre-finished Fibre Cement Panel UP-09-VSF Visible Screw Fix

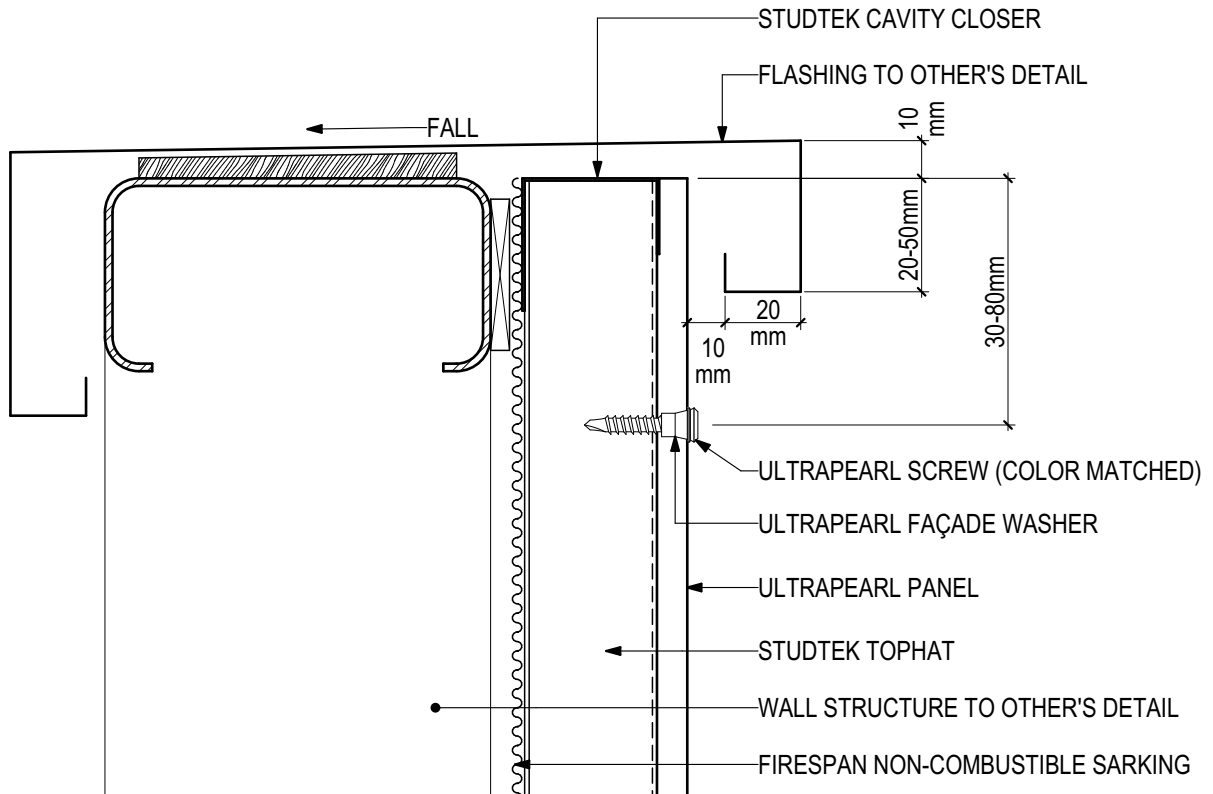

D.15 - PARAPET DETAIL

SCALE 1:2

Disclaimer: These details are general design details for use as a guide. Any use is at their own discretion and risk.